

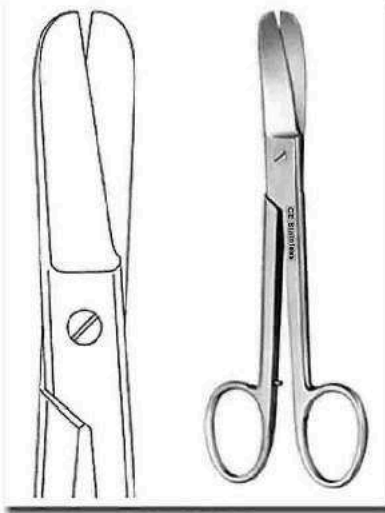

**Spine Instruments**

# ORTHOPEDIC DRESSING INSTRUMENTS



30-100-23  
Lorenz Bandage Scissors  
Heavy Pattern (23 cm / 9")

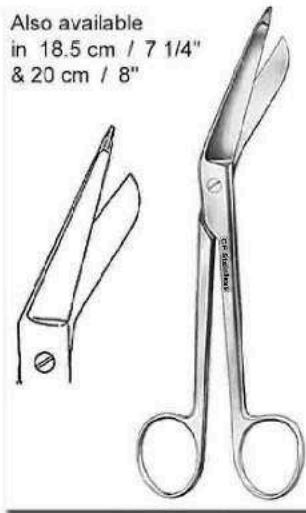

Also available  
in 18.5 cm / 7 1/4"  
& 20 cm / 8"

30-101-14  
Lister Bandage Scissors  
14.5 cm / 5 3/4"

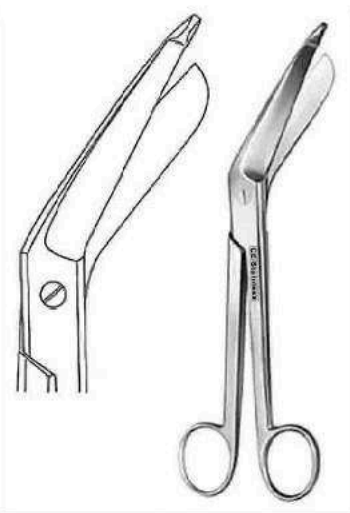

30-102-23  
Bergmann Plaster Shears  
Heavy Pattern  
23.5 cm / 9 1/4"



30-103-20  
Esmarch Plaster Shears  
Heavy Pattern, Short Blades  
20 cm / 8"



Also available  
in 18cm / 7 1/2"

30-104-16  
Bandage Scissors  
16 cm / 6 1/4"  
Black Plastic Rings



30-105-24  
Bruns Plaster Scissors  
24 cm / 9 1/2"  
One Serrated Cutting Edge



B: 26 cm / 10"  
C: 38 cm / 15"

30-106-00  
Stille-Martin  
Plaster Shears  
A: 23 cm / 9"



30-107-15  
Engel Plaster Saw 15.5 cm / 6"



30-108-20  
Hopkins Plaster Knife  
20 cm / 8"  
with Wooden Handle



30-109-18  
Esmarch  
Plaster Knife  
18 cm / 7"



30-110-18  
Reiner  
Plaster Knife  
18 cm / 7"



30-111-21  
Martin  
Plaster Knife  
21 cm / 8 1/4"



45-112-15  
Engel Plaster Saw 15.5 cm / 6"



45-113-18  
Bergmann  
Plaster Saw  
18cm / 7"

# PLASTER CAST INSTRUMENTS

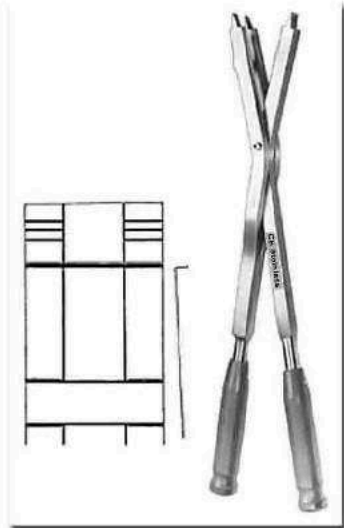

30-114-48  
Hermann Plaster Spreader  
48 cm / 19" Heavy Pattern

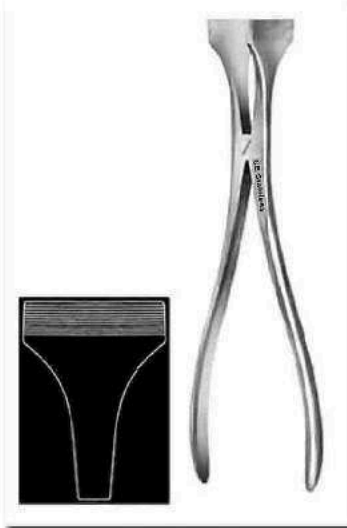

30-115-28  
Hennig Plaster Spreader  
28 cm / 11"

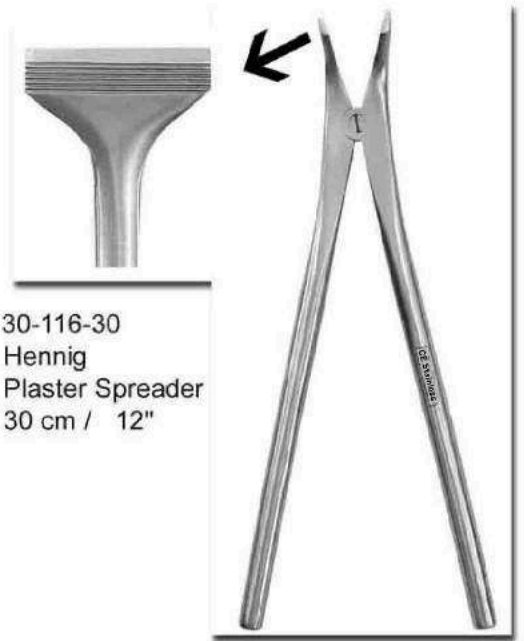

30-116-30  
Hennig  
Plaster Spreader  
30 cm / 12"



30-117-30  
Beeson Plaster Spreader  
1.5 In Blade  
30 cm / 12"



30-118-23  
Walton Plaster Spreader  
w/Spring 3 Prongs  
23 cm / 9"

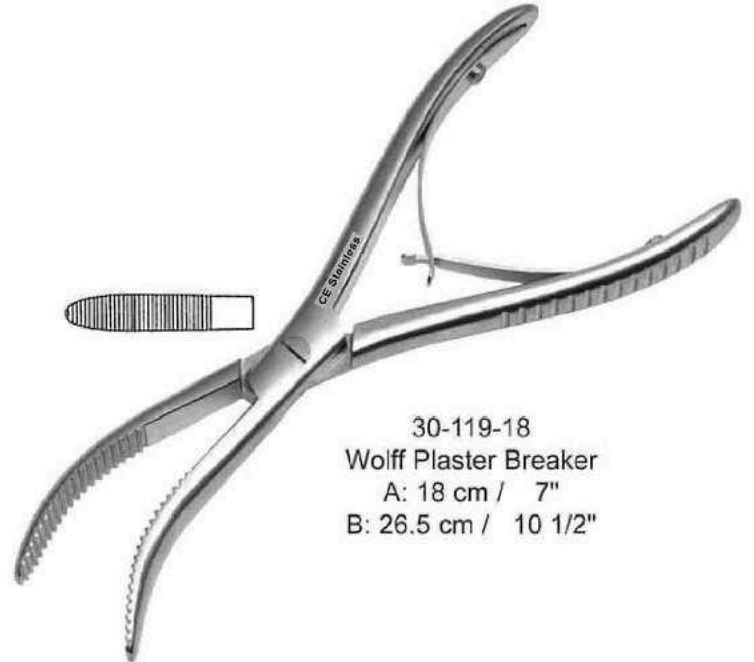

30-119-18  
Wolff Plaster Breaker  
A: 18 cm / 7"  
B: 26.5 cm / 10 1/2"

Also Available  
in Non TC  
Version

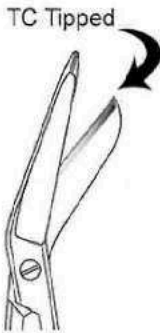

30-120-18-TC  
Lister  
Bandage Scissors  
TC / Handle gold  
18 cm / 7"



30-121-24-TC  
Bruns  
Plaster Scissors  
24 cm / 9 1/2"  
Also Available  
in Non TC  
Version



# AMPUTATION SAWS - GIGLI SAW

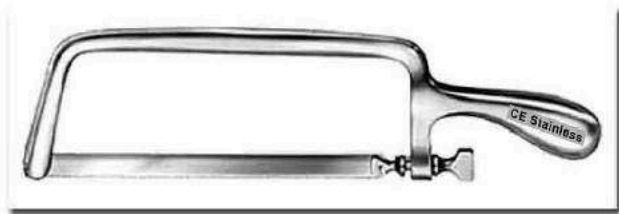

30-122-00 Charrière Amputation Saw  
35 cm / 13 3/4"

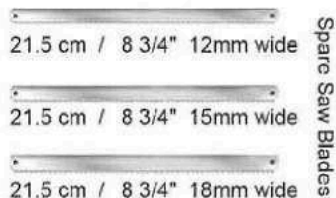

21.5 cm / 8 3/4" 12mm wide

21.5 cm / 8 3/4" 15mm wide

21.5 cm / 8 3/4" 18mm wide

Spare Saw Blades

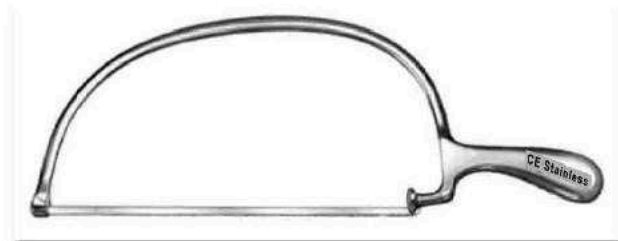

30-123-00 BIER Amputation Saw  
40.5 cm / 16"

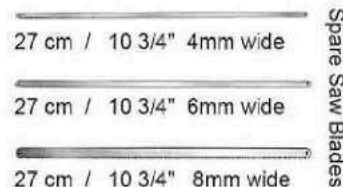

27 cm / 10 3/4" 4mm wide

27 cm / 10 3/4" 6mm wide

27 cm / 10 3/4" 8mm wide

Spare Saw Blades



30-124-24 Langenbeck Amputation Saw  
24.5 cm / 9 3/4"



30-125-29 Satterlee Amputation Saw 29 cm / 11 1/2"  
Also: Spare Saw Blade Available in 20 cm / 8 1/4" Size



30-126-27 Charrière Amputation Saw 27 cm / 10 1/2"



30-127-23 Satterlee Amputation Saw 23 cm / 9"

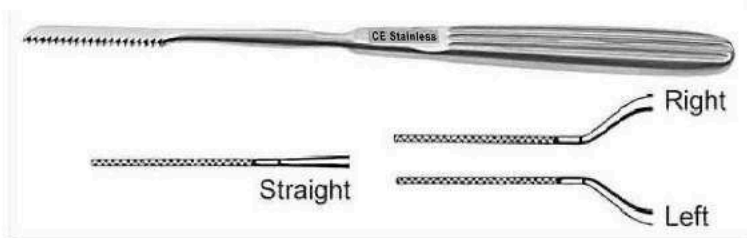

30-128-18 Joseph Amputation Saw 18 cm / 7"



30-129-30 Percy Amputation Shield 30 cm / 12"

- 30-130-00  
A: Gigli Saw 30cm  
B: Gigli Saw 50cm  
C: Tyler Gigli Saw (Large Cut) 30cm  
D: Tyler Gigli Saw (Large Cut) 30cm

enlarged detail



Gigli Saw Handles  
SOLID

30-131-00 Gigli  
Sold in Pair

30-132-01 Struly Gigli  
Sold in Pair



Gigli Saw Handles  
LOOP

30-133-02  
Gigli  
Sold in Pair

30-134-03  
Struly Gigli  
Sold in Pair

30-135-30  
BAILEY Gigli Saw Guide 30cm

30-136-28  
POPPE Gigli Saw Guide 28cm

# REAMERS - AWLS - BONE HOOKS



30-137-13  
Reamer  
13.5 cm / 5 1/4"



30-138-18  
Perthes Reamer  
18 cm / 7"



30-139-21  
Perthes Reamer  
21.5 cm / 8 1/2"



30-140-14  
Reamer  
One concave side  
14 cm / 5 1/2"

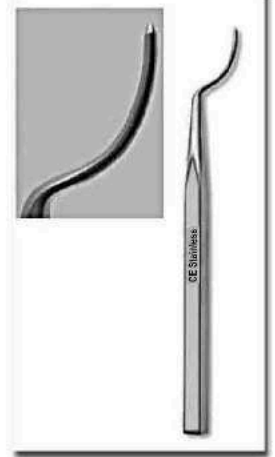

30-141-14  
Glenoid Punch  
20cm / 8"

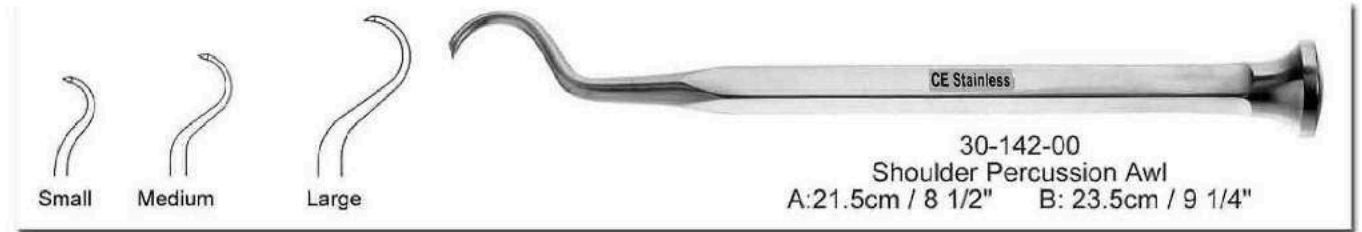

30-142-00  
Shoulder Percussion Awl  
A: 21.5cm / 8 1/2" B: 23.5cm / 9 1/4"



30-143-28  
Kuntscher Diamond Awl 28cm / 11"

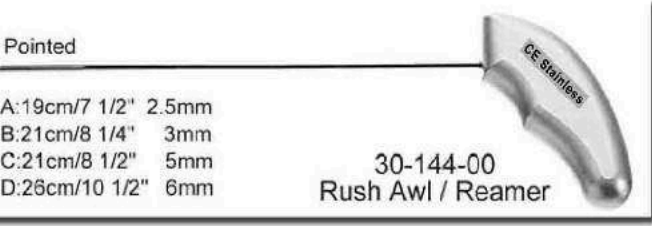

Pointed  
A: 19cm / 7 1/2" 2.5mm  
B: 21cm / 8 1/4" 3mm  
C: 21cm / 8 1/2" 5mm  
D: 26cm / 10 1/2" 6mm

30-144-00  
Rush Awl / Reamer

30-145-00  
Shoulder Penetrating Awl  
Fibre Handle  
A: 18cm / 7"  
B: 23cm / 9"

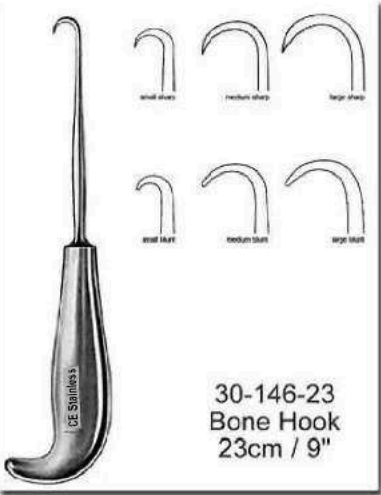

30-146-23  
Bone Hook  
23cm / 9"

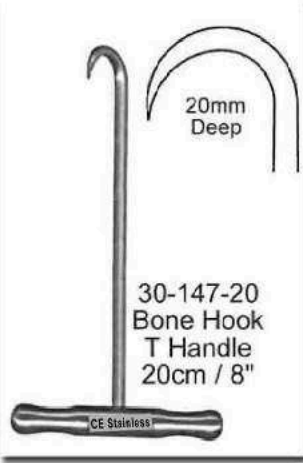

30-147-20  
Bone Hook  
T Handle  
20cm / 8"



30-148-14  
Bone Hook T Fibre Handle  
14cm / 5 5/8"



30-150-25  
Pointed Awl  
Fibre Handle  
25cm / 10"



30-149-00 Volkman Bone Hook

A: 20cm / 8"  
19X27mm  
Sharp

B: 23cm / 9"  
15X20mm  
Blunt

C: 23cm / 9"  
15X20mm  
Sharp

C: 25cm / 9 3/4"  
15X20mm  
Sharp

# HAND BONE DRILLS

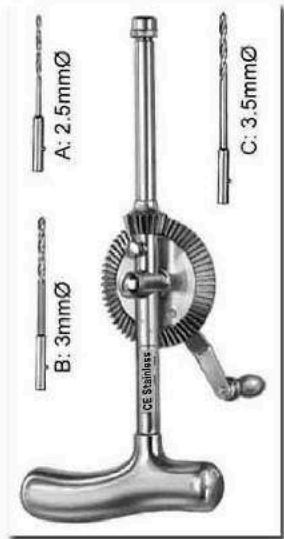

**30-151-24**  
Stille-Sherman Hand Drill  
24 cm / 9 1/2"  
with 3 twist drills



**30-152-20**  
Stille Hand Drill  
20.5 cm / 8"  
w/ 9 Twist Drills

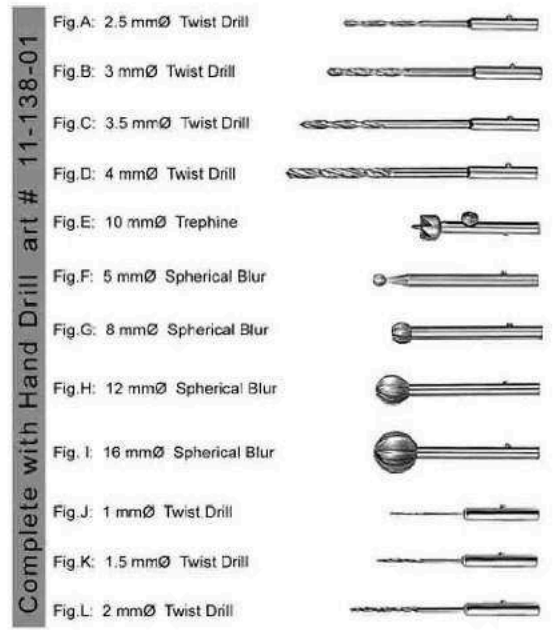

Complete with Hand Drill art # 11-138-01

**30-153-00**

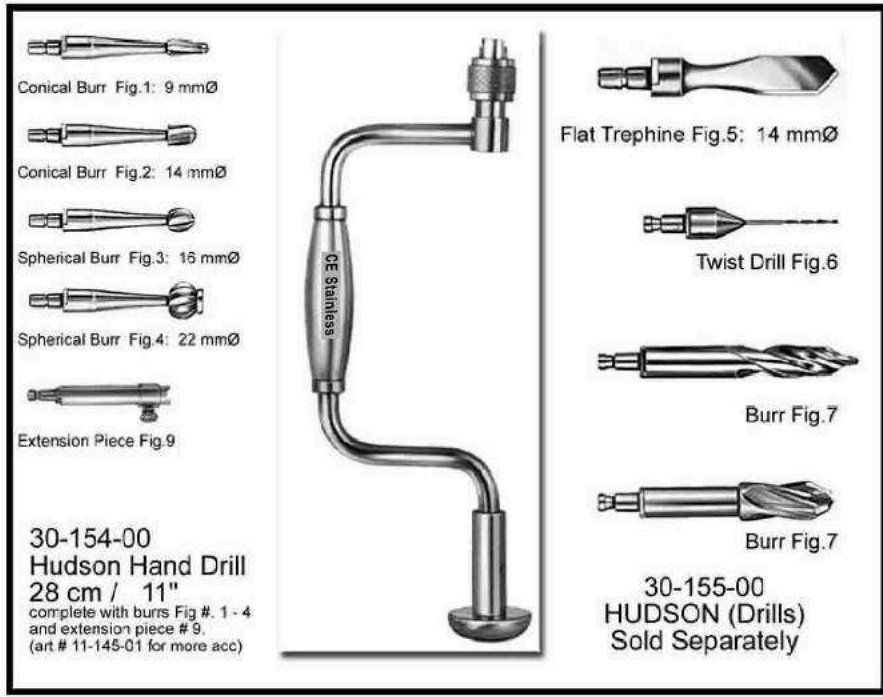

- Conical Burr Fig.1: 9 mmØ
- Conical Burr Fig.2: 14 mmØ
- Spherical Burr Fig.3: 16 mmØ
- Spherical Burr Fig.4: 22 mmØ
- Extension Piece Fig.9

- Flat Trephine Fig.5: 14 mmØ
- Twist Drill Fig.6
- Burr Fig.7
- Burr Fig.7

**30-154-00**  
Hudson Hand Drill  
28 cm / 11"  
complete with burs Fig. #. 1 - 4  
and extension piece # 9.  
(art # 11-145-01 for more acc)

**30-155-00**  
HUDSON (Drills)  
Sold Separately

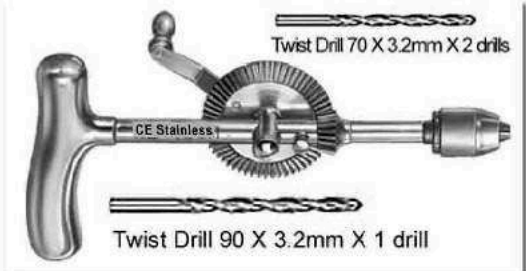

**30-156-00** Moore Hand Drill  
complete with a set of 3 twist drills

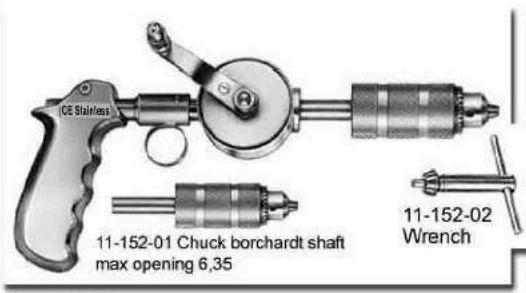

**30-157-00**  
Martin Hand Drill with Chuck & Wrench



**30-158-16**  
Bunnell Hand Drill  
16cm,

Longitudinally Bored with 3-Jaw-Chuck  
Light Metal Housing  
opening up to 4mmØ



**30-159-16**  
Bunnell Type  
Hand Drill 16cm,

Twin Shade Powder Coated  
Longitudinally bored with 3-Jaw-Chuck  
light metal housing opening up to 4mmØ



**30-160-00**  
Ralk Hand Drill

Light Metal Housing  
Literally Angled Handle with 3-Jaw-Chuck  
and key, opening up to 6,35mmØ

# HAND BONE DRILLS - KEYS

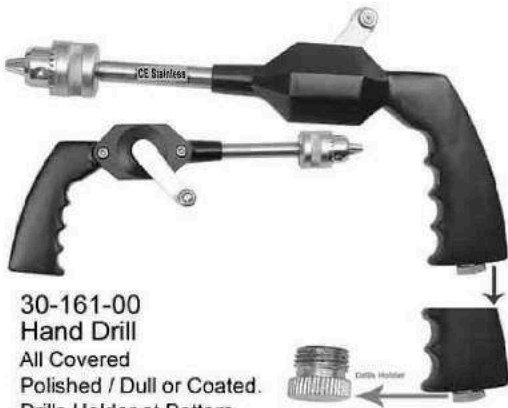

**30-161-00**  
Hand Drill  
All Covered  
Polished / Dull or Coated.  
Drills Holder at Bottom.



**30-162-00**  
Hand Drill  
All Covered  
Light Weight  
Polished / Dull or Coated.  
Key Holder and Self Retaining Locking Mechanism



**30-163-01**  
Box for Hand Drills W/ Art #s: 11-450-00  
and 11-455-00 Outside Artificial Leather  
/ Inside Jumbo Foam



**30-164-00**  
Hand Drill  
Polished / Dull or Coated.  
Operated Horizontally and  
Vertically



Comes with Keys



**30-165-00**  
Hand Drill  
Polished / Dull or Coated.  
All Covered



**30-166-00**  
Hand Drill  
Polished / Dull  
or Coated.  
Open Housing



**30-167-01**  
Hand Drill  
Polished / Dull  
or Coated.  
Open Housing



**30-168-00**  
Hand Drill  
Polished / Dull  
or Coated.  
Semi Closed Housing



**30-169-14** Vickers Easidriver 14 cm / 5 1/2"



**30-170-14** 14cm / 5 1/2"  
Handle W/ Chuck Longitudinally  
Bored Accomodating up to 3,95mm



**30-172-00**  
Handle with chuck  
T-Shaped



**30-171-01**  
Key

**30-173-01**  
Key



**30-174-01**  
Fibre T-Handle Key

# DRILL BITTS - BURRS ETC



30-175-00 5mm Borchardt Shaft Twist Drill  
Long Working End

A: 2.0mm B: 2.5mm C: 3.0mm D: 3.2mm E: 3.5mm F: 4.0mm G: 5.0mm H: 6.0mm I: 7.0mm



30-176-00 5mm Borchardt Shaft Twist Drill

A: 1.0mm B: 1.5mm C: 1.8mm D: 2.0mm E: 2.2mm F: 2.5mm G: 2.8mm H: 3.0mm I: 3.2mm J: 3.5mm K: 4.0mm L: 5.0mm



30-177-00 5mm Borchardt Shaft Flat Trepine

A: 1.8mm B: 2.0mm C: 2.2mm D: 2.5mm E: 3.0mm F: 3.5mm G: 4.0mm H: 5.0mm



30-178-00 5mm Borchardt Shaft Spherical Burr  
A: 3.0mm B: 4.0mm



30-179-00 5mm Borchardt Shaft Spherical Burr  
A: 3.0mm B: 5.0mm

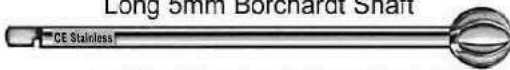

Long 5mm Borchardt Shaft

30-180-00 Doyen Spherical Burr

A:4mm B:6mm C:8mm D:10mm E:12mm F:14mm G:16mm

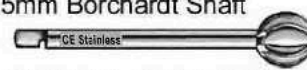

Short 5mm Borchardt Shaft

30-181-00 Doyen Spherical Burr

A:4mm B:6mm C:8mm D:10mm E:12mm F:14mm G:16mm



30-182-03 Doyen Conical Burr  
Coarse Spacing 12mm Dia



30-183-00 Doyen Conical Burr  
Fine Spacing A:8mm / B:10mm



30-184-00 Doyen Cylindrical Burr  
Coarse Spacing A:12mm / B:15mm

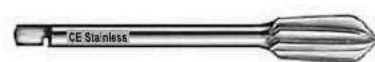

30-185-00 Albee Burr Oval  
Coarse Spacing A:8mm / B:10mm / C:12mm



30-186-03 Albee Burr Pointed  
7mm



30-187-03 Borchardt Burr Oval  
Coarse Spacing 13mm



30-188-03 Flat Burr  
Short Borchardt Shaft 25mm



30-189-03 Toti Trepine  
Short Borchardt Shaft 8mm



# BONE HOLDING CLAMPS



30-190-00  
Standard

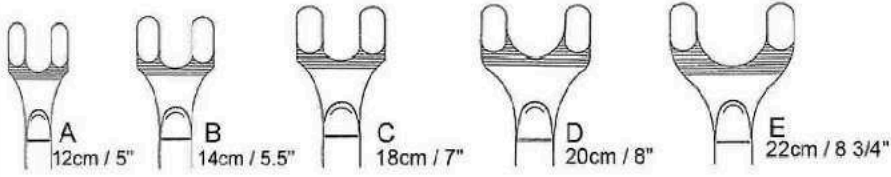

Gerster-Lowman Bone Holding Clamp

30-191-00  
Angled

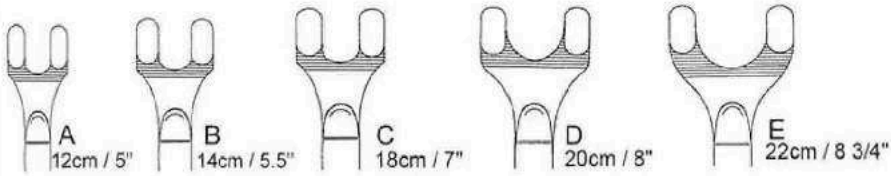

Gerster-Lowman Bone Holding Clamp



30-192-15  
Gerster Traction Bar  
15cm / 6"

1X1 Jaws



30-193-00  
A: 12cm / 5"  
B: 18cm / 7"  
C: 21cm / 8.5"

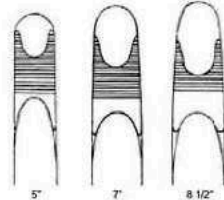

Gerster-Lowman Bone Holding Clamp

2X2 Jaws



30-194-00  
C: 18cm / 7"  
B: 20cm / 8"

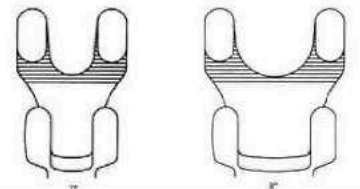

Gerster-Lowman Bone Holding Clamp

# WISE GRIPS - PARALLEL GRIP PLIERS ETC

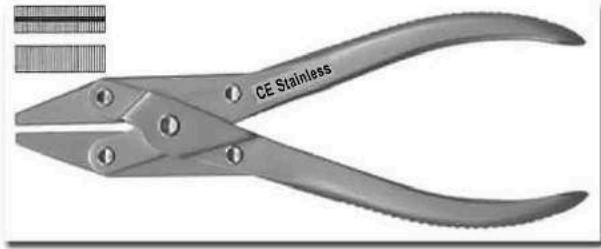

30-195-18 Flat Nose Plier  
18.5 cm / 7 1/4" Parallel Grip SS



30-197-18 Flat Nose Plier / Cutter  
18.5 cm / 7 1/4" Parallel Grip



30-200-22 Long Nose Plier / 22 cm / 8 1/4"



30-201-20  
Vise Grip 20.5 cm / 8"  
Stainless Steel



SLAP HAMMER w/ Threaded Shaft Head  
to be used with 20-131-20 and 30-204-20



SLAP HAMMER w/ Hexa Shaft Head  
to be used with 20-131-20 and 30-206-20



30-207-00 Regular Jaw Locking Plier  
A: 18 cm / 7" B: 20 cm / 8"  
C: 23 cm / 9"



30-196-23  
Vise Grip 23 cm / 9"  
Locking Plier



30-198-20  
Vise Grip 20.5 cm / 8"  
Locking Plier

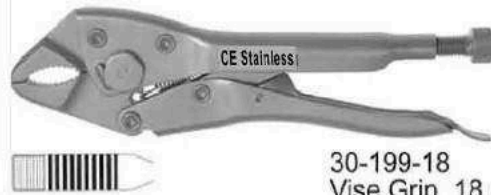

30-199-18  
Vise Grip 18 cm / 7"  
Locking Plier



30-202-30  
Needle Nose Locking Plier  
30 cm / 12"



30-203-25  
Needle Nose Locking Plier  
25.5 cm / 10"



30-205-22  
Needle Nose  
Locking Plier  
22 cm / 8.5"

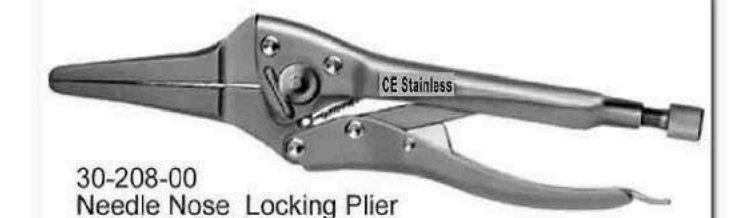

30-208-00  
Needle Nose Locking Plier  
A: 22 cm / 8.5"  
B: 25.5 cm / 10"  
C: 30 cm / 12"

# BENDING - WIRE CUTTING PLIERS



30-209-15  
Combi-Flat Nose Pliers 15 cm / 6"  
for Bending & Cutting



30-212-18 Round / Flat Nose Pliers  
18 cm / 7"



30-214-17 Flat Nose Pliers  
17 cm / 6 3/4" with crosswise groove

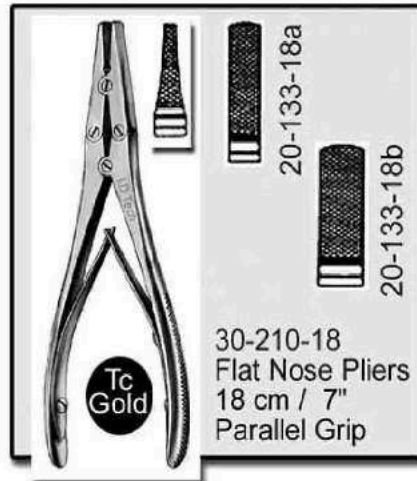

30-210-18  
Flat Nose Pliers  
18 cm / 7"  
Parallel Grip



30-211-13 Flat Nose Pliers  
13.5 cm / 5 1/4"



30-213-16 Hackstock Flat  
Nose Pliers 16cm / 6 1/4"



30-215-17  
Flat Nose Pliers 17.5 cm / 7"



30-216-19  
Flat Nose Pliers Pointed 19.5 cm / 7 3/4"



30-217-15  
Platypus Nail  
Pulling Forceps  
15.5 cm / 6 1/4"

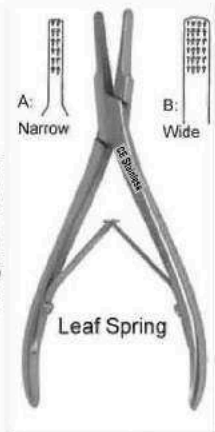

30-218-15  
Platypus Nail  
Pulling Forceps  
15.5 cm / 6 1/4"



30-219-15  
Round Nose Pliers  
15.5 cm / 6 1/4"



30-220-15  
Needle Nose Pliers  
15.5 cm / 6 1/4"

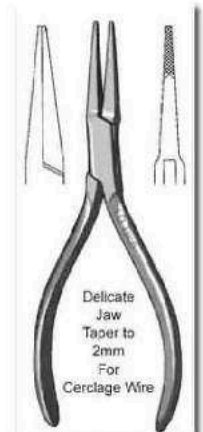

30-221-15  
Flat Nose Pliers  
15 cm / 6"

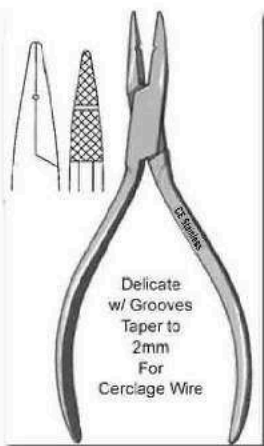

30-222-13  
Needle Nose Pliers  
13.5 cm / 5 1/4"

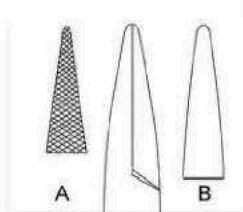

30-223-14  
Needle Nose Pliers  
Taper to 2mm Tip  
14 cm / 5 1/2"  
A: Fine Cross Serration  
B: Smooth



30-224-18  
Wire Cutting Pliers  
18.5 cm / 7 1/4"  
Hard wires up to 1.8mm Ø



30-225-16  
Martin "Diamant"  
Hard wires up to 1.5mm Ø

# BENDING - WIRE CUTTING PLIERS



30-226-14  
14 cm / 5 1/2"  
Cerclage Pliers / Cutter

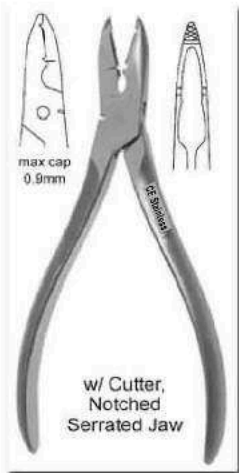

30-227-20  
20 cm / 8"  
Wire Bending Pliers

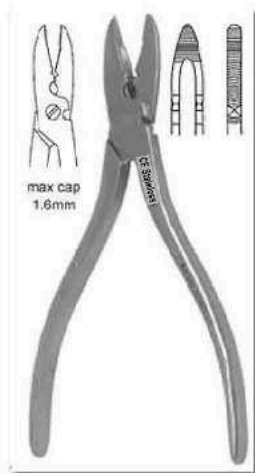

30-228-15  
15 cm / 6"  
Wire Bending Pliers



30-229-20  
20 cm / 8"  
Wire Bending Pliers  
TUNGSTEN  
CARBIDE



30-230-15  
15 cm / 6"  
Needle Nose Pliers

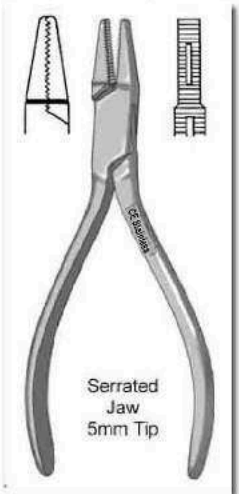

30-231-14  
14 cm / 5 1/2"  
Flat Nose Pliers

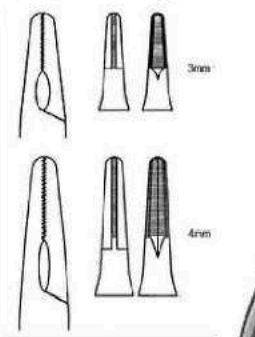

30-232-00  
K-Wire Pliers  
A: 13 cm / 5"  
B: 17.5 cm / 7"



30-233-19  
19 cm / 7 1/2"  
Screw/Pin  
Removing Pliers

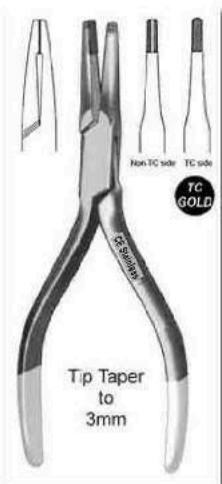

30-234-14  
14 cm / 5 1/2"  
Pin Puller  
Grips Small Pins

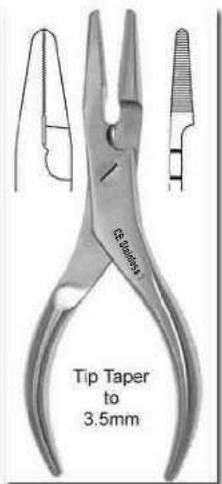

30-235-16  
16 cm / 6 1/2"  
Flat Nose Pliers  
w/ Cutter  
for Cerclage Wire



30-236-19  
19 cm / 7 1/2"  
Narrow  
Nose Pliers  
Heavy Jaws  
for Pulling  
Wire / Pins



30-237-17  
17.5 cm / 7"  
Long Jaw Pliers  
2inch Long Jaw  
Delicate

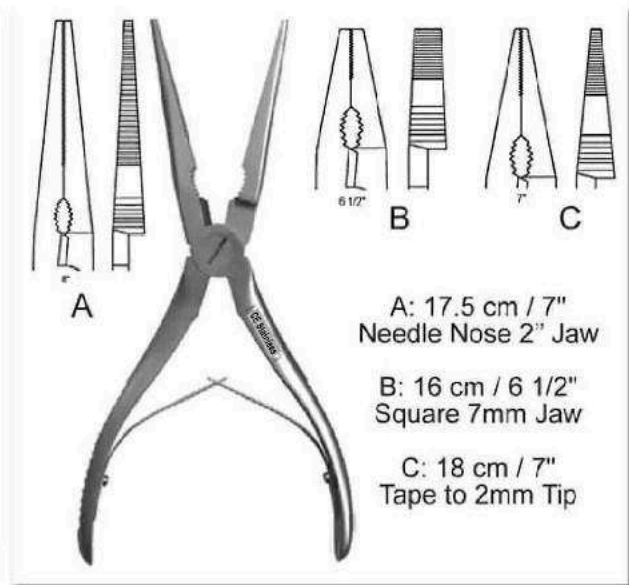

30-238-00  
UNIVERSAL Pliers  
Serrated w/ Heavyduty Spring and Cutting Edge  
Max Cutting Cap: 1.1mm

# BENDING - PASSERS ETC

All TUNGSTEN CARBIDE

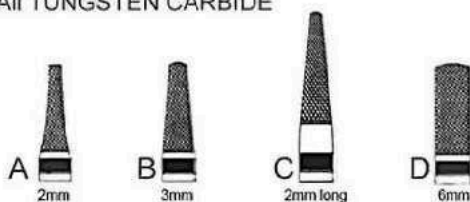

- A: 2mm Delicate Jaw TC
- B: 3mm Jaw TC
- C: 2mm Long Jaw TC
- D: 6mm Jaw TC

30-241-00  
18 cm / 7"  
Double Action Wire Extraction Plier

TC GOLD

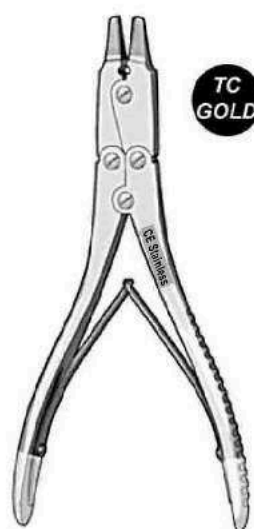

30-239-20  
20 cm / 8"  
Slip Joint Pliers



30-240-21  
21 cm / 8 1/2"  
Lineman Pliers



30-242-19 19 cm / 7 1/2" Gratloch Wire Bender

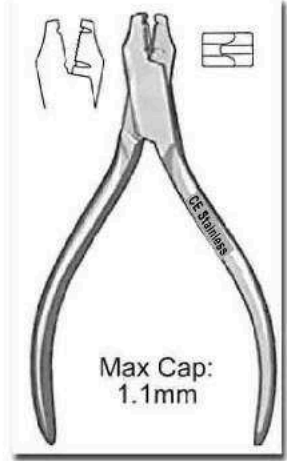

30-243-13  
13.5 cm / 5"  
K-Wire / Plate Bender



30-244-14  
14.5 cm / 5 1/2"  
K-Wire / Plate Bender

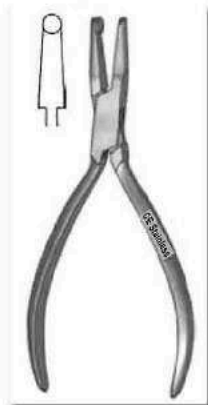

30-245-13  
13.5 cm / 5"  
Mini Plate Bending Pliers

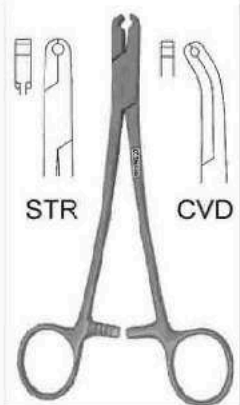

30-246-00  
18 cm / 7 1/4"  
Rod Holder  
A: 4.0mm Rod  
B: 4.76mm Rod  
C: 6.35mm Rod  
Straight or Curved

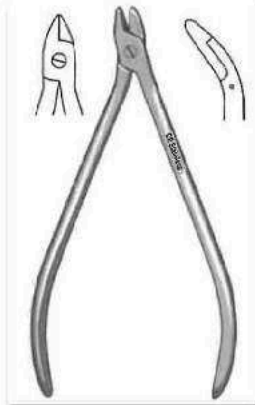

30-247-14  
14.5 cm / 5 1/2"  
Plate Bending Pliers



30-248-16  
16 cm / 6 1/2"  
Wire Pulling Forceps

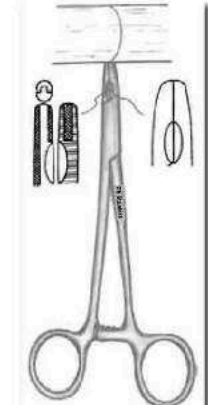

30-249-16  
16 cm / 6 1/4"  
Wire Twister / Tightner

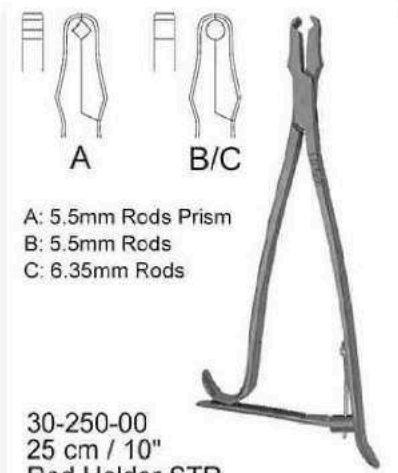

- A: 5.5mm Rods Prism
- B: 5.5mm Rods
- C: 6.35mm Rods

30-250-00  
25 cm / 10"  
Rod Holder STR

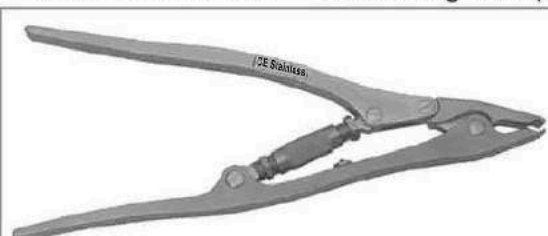

30-251-21  
21 cm / 8 1/2"  
Rod Gripper  
Adjustable

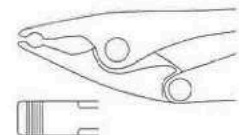

# BONE WIRE MANAGEMENT



30-252-21  
Loute Wire Tightener (21 cm / 8 1/4")



30-253-11  
Wire Tightener  
w/ T Handle  
11 1/2 cm / 4 1/2"



30-254-21  
Wire Tightener 12 cm / 4 3/4")

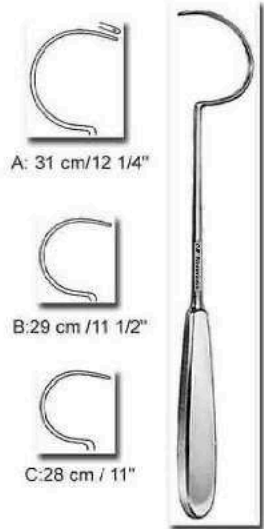

A: 31 cm / 12 1/4"  
B: 29 cm / 11 1/2"  
C: 28 cm / 11"

30-255-00  
Demel Wire Guide



CVD  
Crochet Hook  
18cm / 7 1/4"

30-256-18  
Bankert Ligature Carrier



CVD  
Crochet Hook  
Fiber Handle  
A: 18cm / 7"  
B: 23cm / 9"

30-257-00  
Suture Passer



CVD  
Suture Hole  
Fiber Handle  
A: 18cm / 7"  
B: 23cm / 9"

30-258-00  
Suture Passer

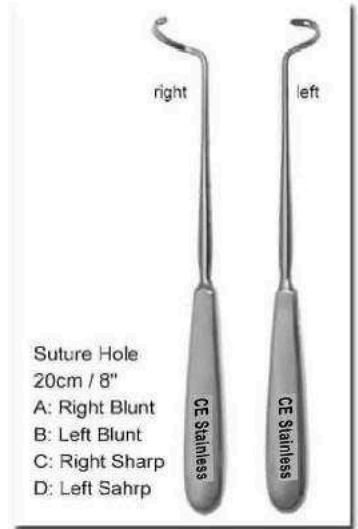

Suture Hole  
20cm / 8"  
A: Right Blunt  
B: Left Blunt  
C: Right Sharp  
D: Left Sharp

30-259-00  
Deschamps Ligature Carrier

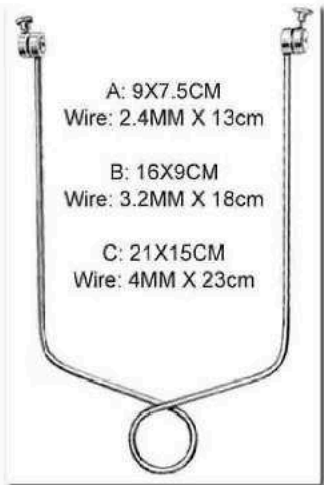

30-260-00  
Böhler Extension  
Bow for femur & knee

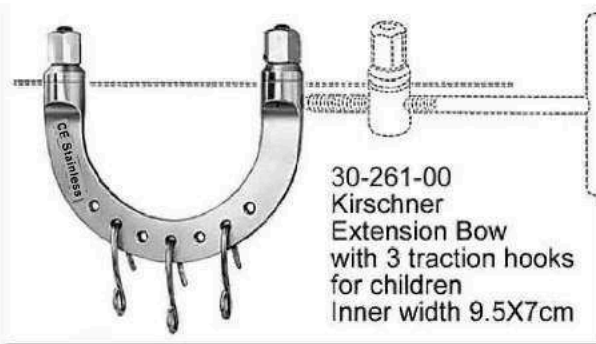

30-261-00  
Kirschner  
Extension Bow  
with 3 traction hooks  
for children  
Inner width 9.5X7cm

20-143-02  
for Wrist / Ankle  
10.5X10.5cm

20-143-03  
for Elbow  
12X12cm

20-143-04  
for Knee  
15.5X15.5cm

20-143-05  
for Femur  
20X15.5cm



30-262-00 (Kirschner) Extension Bow  
A: Small: 18.5 cm / 7 1/4"  
B: Large: 26.5 cm / 10 1/2"  
with 3 traction hooks



30-263-18  
Wire Strainer 18.5 cm / 7 1/4"

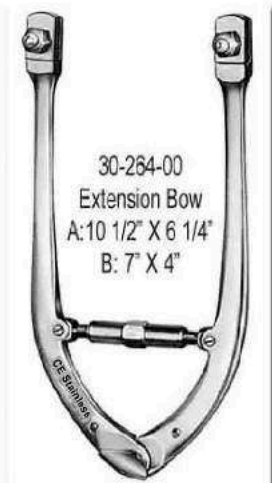

30-264-00  
Extension Bow  
A: 10 1/2" X 6 1/4"  
B: 7" X 4"



30-265-00  
Fixation Discs  
for wire drills, pair

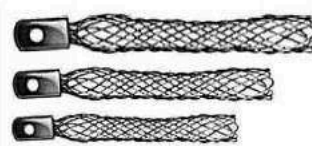

30-266-00 Extension Sleeve  
Small / Medium / Large

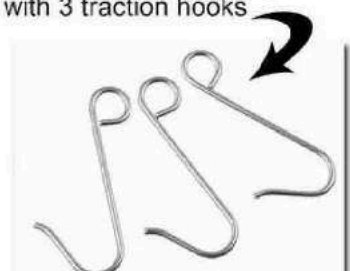

30-267-00 Traction Hook  
for Extension Bows



30-268-20  
Wrench 20cm / 8"

**FINGER RING CUTTING - LEAD HANDS - BIOPSY TOOLS**



30-269-00  
Martin-Ideal  
Finger Nail Drill



30-273-14  
Radolf  
Nail Extracting Forceps

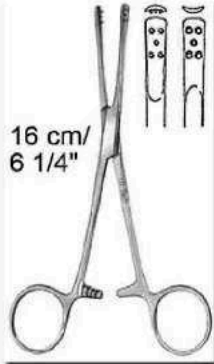

16 cm /  
6 1/4"  
30-274-16  
Nail Extracting  
Forceps



30-275-18  
Martin Finger  
Ring Saw 18.5 cm / 6 3/4"  
Spare Blades are Available  
Separately



30-270-10 Feldheim Tourniquet  
10cm / 4"



30-271-16  
Walton  
Finger Ring Saw  
16 cm / 6 1/4"  
Spare Blades are  
provided separately



30-272-17  
Finger Ring Saw  
17 cm / 6 3/4"  
Spare  
Blades are provided separately



Stainless Steel  
Black Color



Stainless Steel  
Color

30-276-00  
Finger Ring Saw Cutter Spare

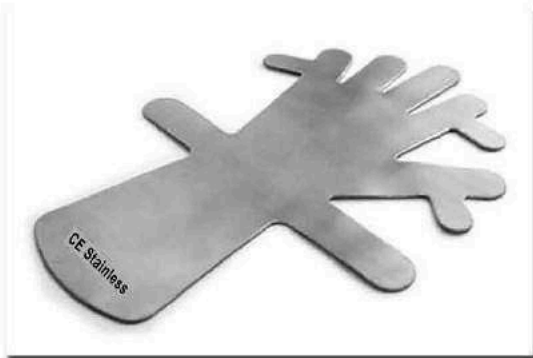

30-277-00 Lead Hand for Kids / Adults



30-278-00 Lead Hand for Kids / Adults



Outer Dia: 5mm  
Inner Dia: 3mm

30-279-00  
Chamy-OSU Bone Biopsy Instruments  
Consisting of trocar, a toothed trephine  
and a plunger for taking tibial and  
iliac bone grafts through a closed techniqu  
22 cm / 8 3/4"



30-280-00  
Chamy Cancellous Bonegraft Mill  
Outer Dia: 17mm  
Inner Dia: 16mm



30-281-00  
Chamy Bone Biopsy Instruments  
A: Outer Dia: 5mm Inner Dia: 4mm  
B: Outer Dia: 8mm Inner Dia: 7mm  
22 cm / 8 3/4"

# TAMPER - IMPACTORS - PACKERS

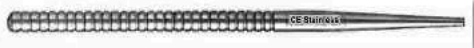

30-282-00 15.5cm/6" Bone Tamper Tip Sizes: 2-3-4-5-6-8-10mm



A: 2mm  
B: 3mm  
C: 4mm  
D: 5mm

F: 6mm  
G: 8mm  
H: 9mm  
I: 10mm

Knurling Handle

30-283-00 Bone Tamper



20mm



3mm 5mm 8mm

Cross-Serrated

A: 3mm  
B: 5mm  
C: 8mm



30-284-17 17cm / 6 1/2" Bone Impactor / Teflon Tip

30-285-00 20cm / 8" Caspar Bone Tamper

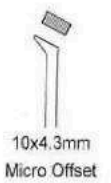

10x4.3mm  
Micro Offset



10x4.3mm  
Micro Lateral

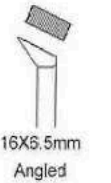

16X5.5mm  
Angled

30-286-00 21cm / 8 1/2" Lumbar / Cervical Impactor

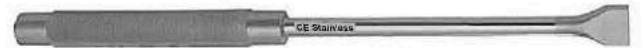

12.5x7mm  
Std

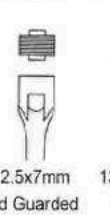

12.5x7mm  
Std Guarded



13x10mm  
Wide



13x10mm  
Wide Guarded



11.5x6.5mm  
Offset



11.5x6.5mm  
Narrow

30-287-00 21cm / 8 1/2" Lumbar / Cervical Impactor

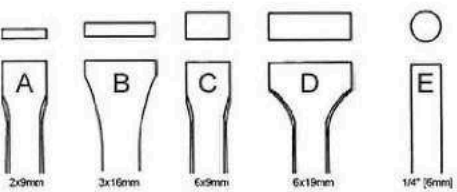

A: 2X9mm B: 3X16mm  
C: 6X9mm D: 6X19mm  
E: 6mm Dia

30-288-00 25cm / 10" Bone Chip Packer

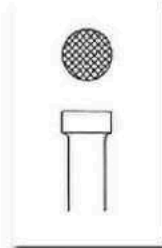

9.5mm DIA

30-289-43 43cm / 17" Bone Tamper





# BONE FILES - RASPS



30-290-30 Putti Bone Rasp Round / Semi Round  
30cm / 11 3/4"



30-292-28 Bone File 28 cm / 11" w/ Hollow Handle  
Semi Round



30-294-22 Bone File 22 cm / 8 3/4"  
Flat / Round



30-296-18 Bone File 18 cm / 7"  
Fibre Handle / Cross-Hatch



30-291-27 Putti Bone Rasp Curved / Straight  
27cm / 10 3/4"



30-293-24 Bone File 24.5 cm / 9 3/4"  
w/ Hollow Handle Semi Round



30-295-22 Bone Rasp 22 cm / 8 3/4"  
Flat / Round



30-297-18 Bone File 18 cm / 7"  
Fibre Handle / Linear



30-298-18 Bone File 18 cm / 7"  
Fibre Handle / Straight



300-299-18 Bone File 18 cm / 7"  
Fibre Handle / CVD Forward



30-300-18 Bone File 18 cm / 7"  
Fibre Handle / CVD Backward

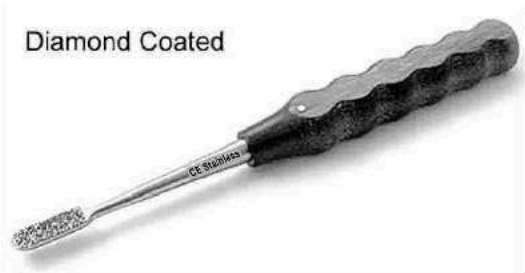

30-301-18 Bone File 18 cm / 7"  
Fibre Handle / STR Diamond Coated



30-302-18 Bone File 18 cm / 7"  
Fibre Handle / CVD Diamond Coated

# BONE FILES - RASPS

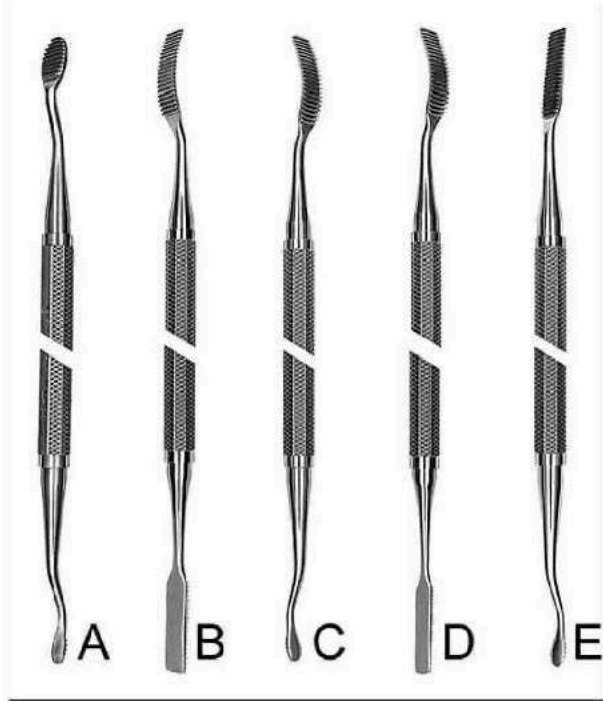

30-303-00 A / B / C / D / E  
Miller-Colburn Bone File 18 cm / 7" Downwards Cut

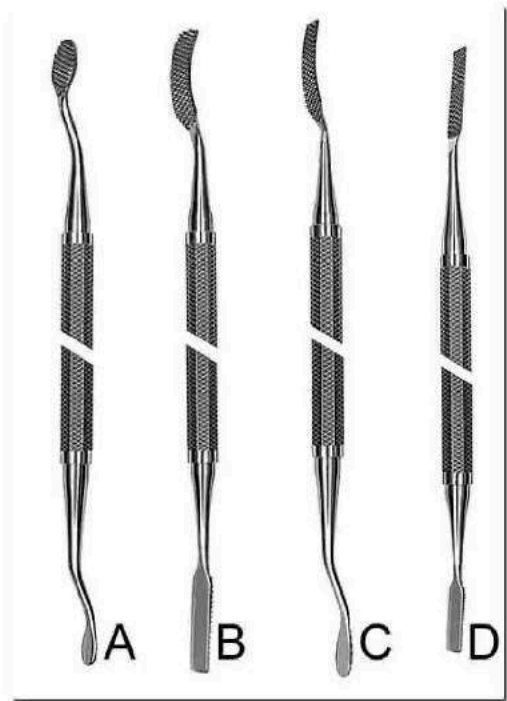

30-304-00 A / B / C / D /  
Miller-Colburn Bone File 18 cm / 7" Cross Cut



30-305-21  
Bone Rasp  
21 cm / 8.5"  
13mm  
Fine/Coarse  
Straight

30-306-16  
Bone Rasp  
Joseph  
16cm / 6.25"  
8mm  
Fine Cross Serr  
Straight

30-307-19  
Bone Rasp  
Lewis  
19cm / 7.5"  
8mm  
Straight

30-308-20  
Bone Rasp  
Cottle  
20cm / 8"  
7mm  
Plain Serr  
Downward

30-309-18  
Bone Rasp  
Maltz  
18cm / 7"  
9mm  
Plain  
Coarse Serr  
Downward

30-310-18  
Bone Rasp  
Aufricht  
18cm / 7"  
9mm  
Coarse Serr  
CVD



30-311-21  
Bone Rasp  
Fomon  
21 cm / 8.5"  
8mmX40mm  
Coarse Serr  
4 Sided  
Flat / Covex Baldes



30-312-21  
Bone Rasp  
Fomon  
21 cm / 8.5"  
8mmX40mm  
Fine Serr  
4 Sided  
Flat / Covex Blades



30-313-21  
Bone Rasp  
Kleinert Kurtz  
21 cm / 8.5"  
8mmX45mm  
Fine/Coarse Serr  
4 Sided  
Flat / Covex Blades



30-314-21  
Bone File / Rasp  
21 cm / 8.5"  
18mm  
Fine / Coarse Serr

# RETRACTORS - BONE LEVERS



30-315-16 Bone Lever  
16 cm / 6 1/4"

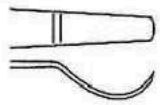

30-318-16 Hohman, Mini Bone Lever  
16 cm / 6 1/4" 14 mm tip

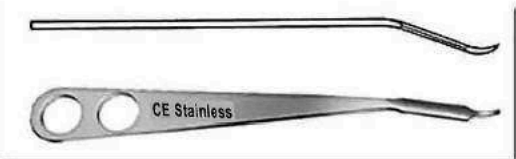
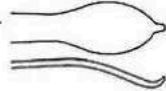

30-320-22 Hohmann Bone Lever  
22 cm / 8 3/4" 8 mm Tip narrow tip

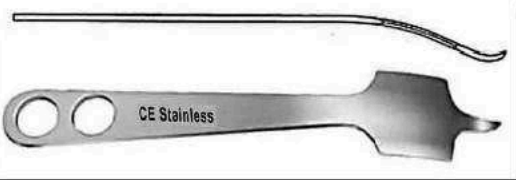

30-322-23 Hohmann Bone Lever  
23.5 cm / 9 1/4" 43 mm Tip narrow tip

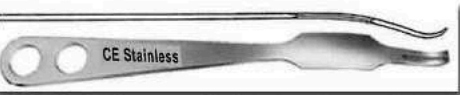

30-325-25 Lange-Hohmann Bone Lever  
25 cm / 9 3/4" 22mm Tip wide tip with groove



30-327-00 Hohmann Bone Lever  
27.5 cm / 10 3/4" 24mm Tip wide, round tip



Sizes Available  
A: 75X30mm  
B: 100X30mm

30-332-00 A / B Taylor Spinal Retractor  
16 cm/6 1/4" pointed end



30-316-16 Hohman, Mini Bone Lever 16 cm / 6 1/4" 6mm tip



30-317-16 Hohman, Mini Bone Lever 16 cm / 6 1/4" 8 mm tip

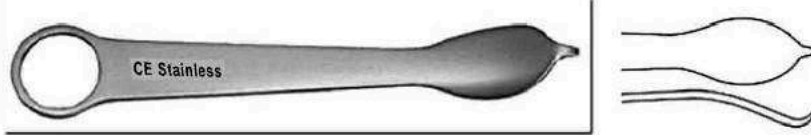

30-319-12 Hohman, Mini Bone Lever 12 cm / 4 3/4" 14 mm tip



30-323-00 Hohmann Bone Lever  
13cm/5" A:3mm B:5mm C:7mm

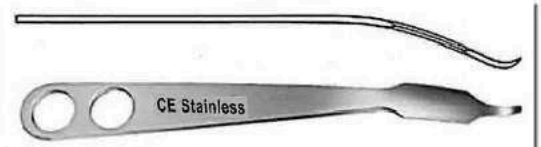

30-321-23 Hohmann Bone Lever  
23.5 cm / 9 1/4" 18 mm Tip narrow tip

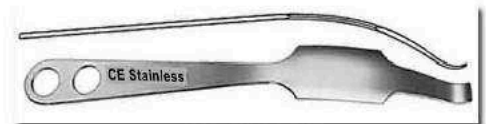

30-324-29 Hohmann Bone Lever  
29 cm / 11 1/2" 35mm Tip wide tip

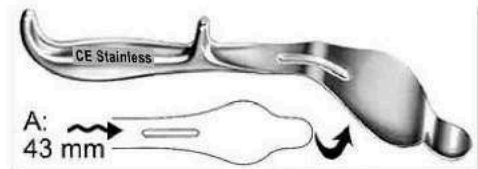

30-326-24 A / B Bennett Bone Lever  
24 cm / 9 1/2"



30-328-25

Hohmann Bone Lever 25 cm / 9 3/4" 70 mm Tip narrow tip



20-330-23

Hohmann Bone Lever 23.5 cm / 9 1/4" 43mm Tip narrow tip



30-329-26 Blount Knee Retractor  
26.5 cm / 10 1/2" blunt



30-331-26 Blount Knee Retractor  
26.5 cm / 10 1/2"



30-333-25 Hohmann Bone Lever 25.5 cm / 10" 22mm Tip wide tip



30-334-17 Blount Knee Retractor  
17.5 cm / 7"

# RETRACTORS - BONE LEVERS



A: 32X81mm  
B: 38X81mm

30-335-19 Fukuda Retractor  
19 cm / 7 1/2" T Handle



30-336-28 Browne - Deltoid Retractor  
28 cm / 11" T Handle w/ Ring



2 Blunt Prongs

30-337-18 Humeral Head Retractor  
18 cm / 7" Strong Curved

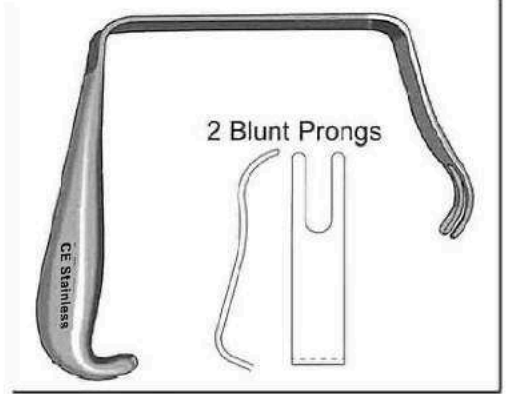

2 Blunt Prongs

30-338-18 Bristow / Bankart  
Humeral Retractor  
18 cm / 7"



22mm  
Blade  
1 Sharp  
Prong

30-339-25  
Capsule Retractor  
25 cm / 10"



22mm  
Blade  
2 Sharp  
Prong

30-340-25  
Capsule Retractor  
25 cm / 10"

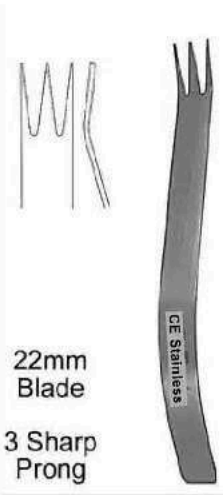

22mm  
Blade  
3 Sharp  
Prong

30-341-25  
Capsule Retractor  
25 cm / 10"

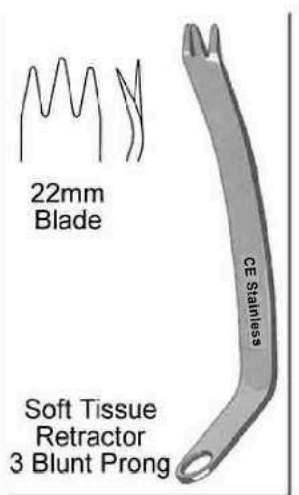

22mm  
Blade

Soft Tissue  
Retractor  
3 Blunt Prong

30-342-19  
Bristow/Bankart  
19 cm / 7 1/2"



A: 13MM  
B: 18mm  
C: 20mm  
D: 23mm

30-343-00  
Blade Retractor  
19 cm / 7 1/2"

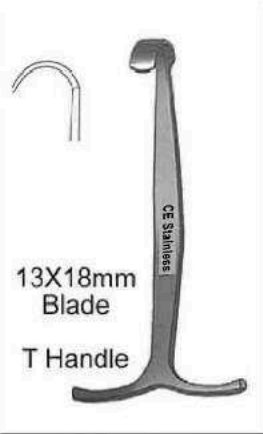

13X18mm  
Blade  
T Handle

30-344-13  
Smillie Retractor  
13cm / 5"



13X55mm  
Blade  
T Handle

30-345-14  
Smillie Retractor  
14cm / 5 1/2"



Small: 19X32mm  
Medium: 19X45mm  
Large: 19X60mm  
T Handle

30-346-00  
Smillie Retractor  
Angled Blade 14cm / 5 1/2"



Medium Blade:  
57/69mm Deep  
11mm Wide

Large Blade:  
63/76mm Deep  
11mm Wide

30-347-15  
Z Knee Retractor  
15 cm / 6"

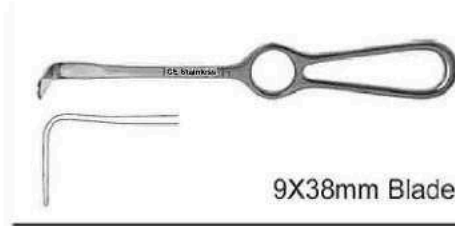

9X38mm Blade

30-348-22  
Knee Retractor  
22 cm / 8 1/2" Ring Handle

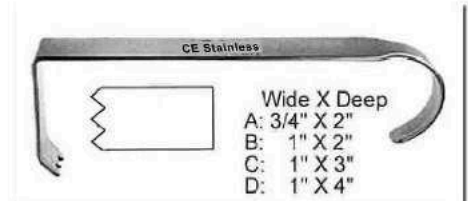

Wide X Deep  
A: 3/4" X 2"  
B: 1" X 2"  
C: 1" X 3"  
D: 1" X 4"

30-349-24  
Hibbs Retractor  
24 cm / 9 1/2" Sharp Teeth

# RETRACTORS - BONE LEVERS

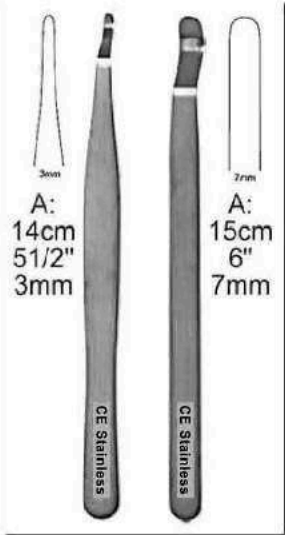

30-350-00  
Hayes Retractor

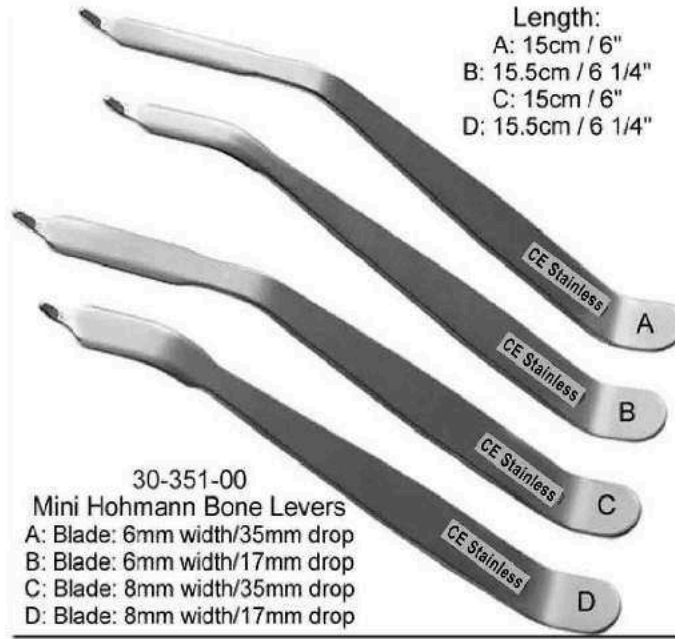

30-351-00  
Mini Hohmann Bone Levers  
A: Blade: 6mm width/35mm drop  
B: Blade: 6mm width/17mm drop  
C: Blade: 8mm width/35mm drop  
D: Blade: 8mm width/17mm drop

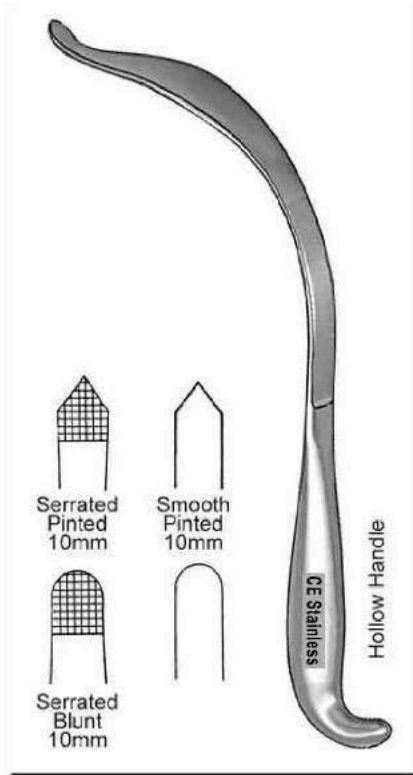
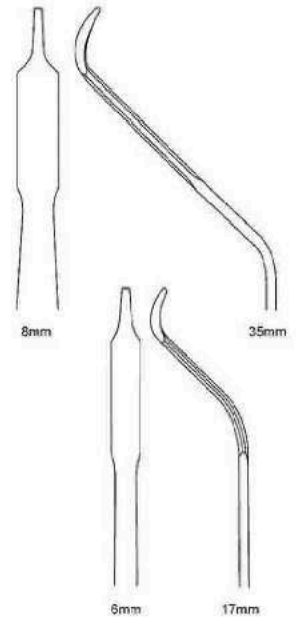

30-352-26  
Aufranc Cobra Retractor  
A: 26cm / 10 1/2"

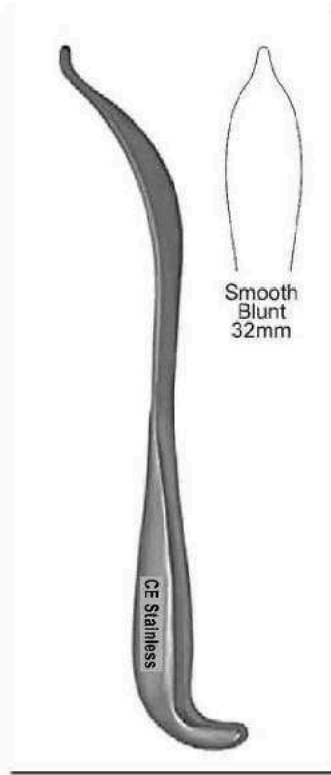

30-353-27  
Aufranc Cobra Retractor  
A: 27.5cm / 11"

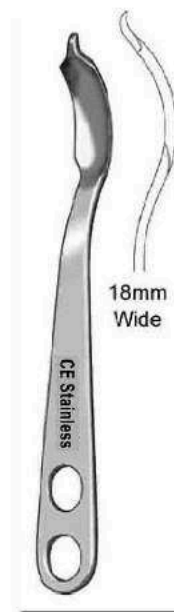

30-354-23  
Humeral Head  
Retractor  
23cm / 9"

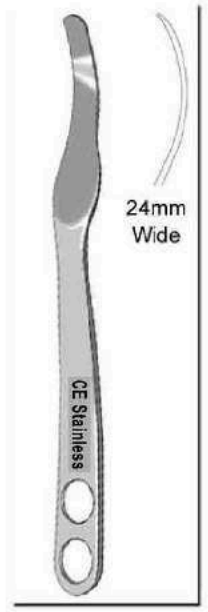

30-355-26  
Pelvic Retractor  
Single Prong  
A: 26cm / 10 1/2"



30-356-30  
Murphy Bone Skid  
30cm / 12"

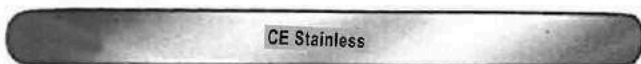

30-357-00  
Ribbon Retractor Malleable  
30cm / 12"

- A: 6" X 6mm
- B: 6" X 12mm
- C: 6" X 16mm
- D: 6" X 19mm
- E: 7 1/2" X 25mm

## Sizes Available

- F: 8" X 6mm
- G: 8" X 10mm
- H: 8" X 12mm
- I: 8" X 16mm
- J: 8" X 19mm
- K: 13" X 19mm
- L: 13" X 30mm
- M: 13" X 38mm
- N: 13" X 45mm
- O: 13" X 50mm
- P: 13" X 65mm
- Q: 13" X 75mm

# RETRACTORS - BONE LEVERS

30-358-00  
St. Mark's Pelvic Retractor  
Angled Blade

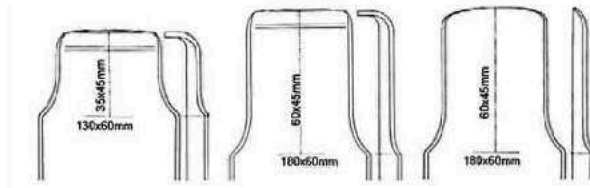

A: 29cm / 11 1/2"  
With Lip

B: 33cm / 13"  
With Lip

B: 33cm / 13"  
Without Lip

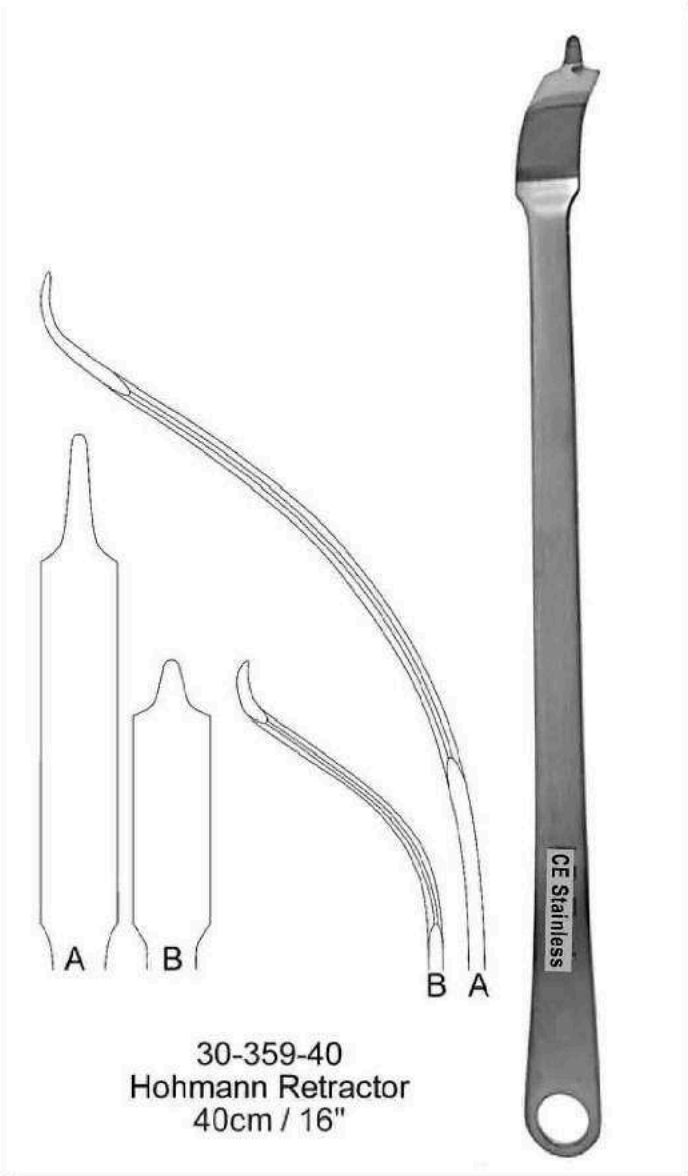

30-359-40  
Hohmann Retractor  
40cm / 16"

A: 22mm Blade  
2 Finger Rings Long Round → 

B: 22mm Blade  
1 Finger Ring Short Round → 

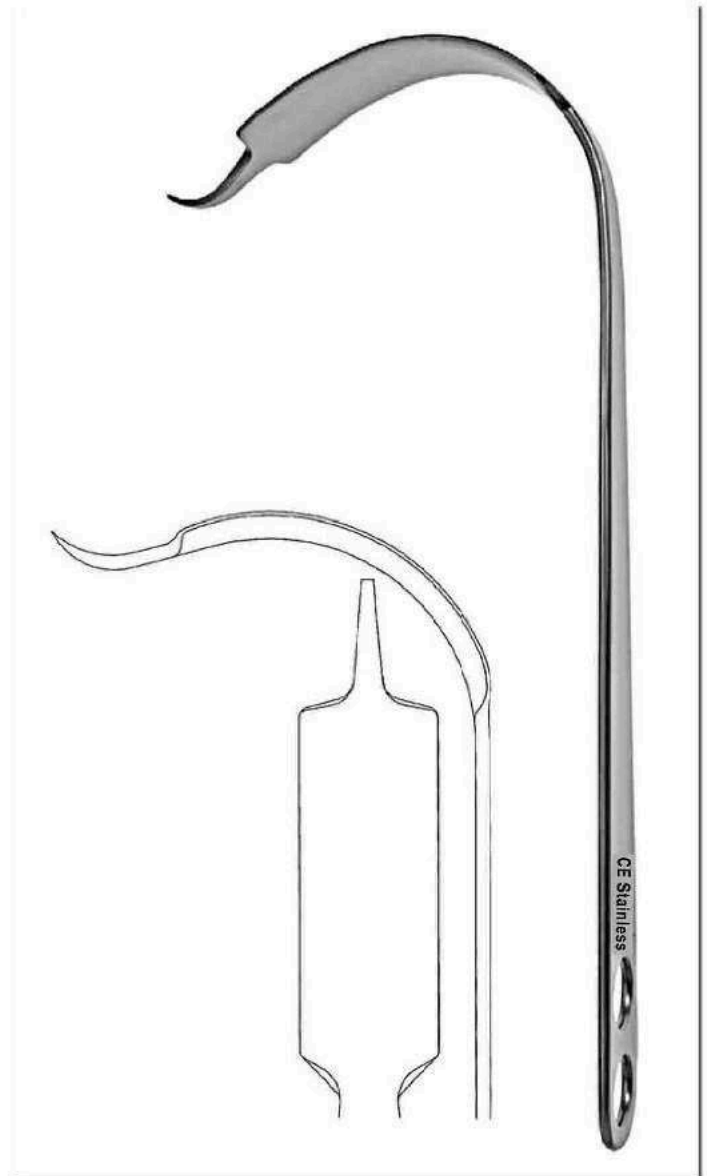

30-360-33  
Hohmann Retractor  
33cm / 13"  
40mm Blade Width

# CHISELS - GOUGES - OSTEOTOMES



30-361-7  
Virchow  
Skull Breaker  
7.5 cm / 3"

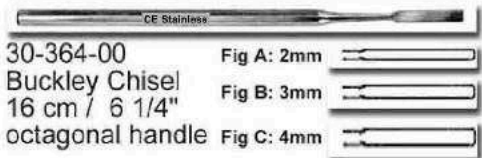

30-364-00 Buckley Chisel  
16 cm / 6 1/4" octagonal handle  
Fig A: 2mm  
Fig B: 3mm  
Fig C: 4mm

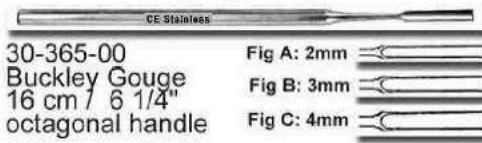

30-365-00 Buckley Gouge  
16 cm / 6 1/4" octagonal handle  
Fig A: 2mm  
Fig B: 3mm  
Fig C: 4mm

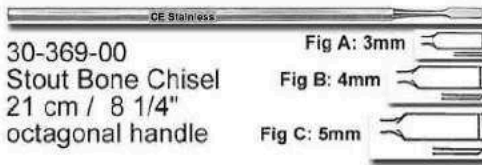

30-369-00 Stout Bone Chisel  
21 cm / 8 1/4" octagonal handle  
Fig A: 3mm  
Fig B: 4mm  
Fig C: 5mm

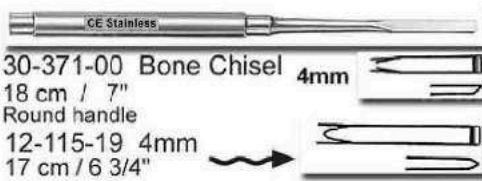

30-371-00 Bone Chisel  
18 cm / 7" Round handle  
12-115-19 4mm  
17 cm / 6 3/4"

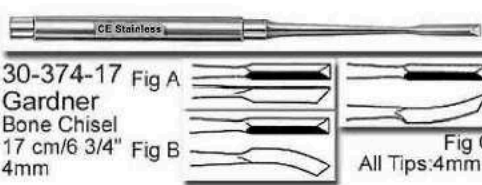

30-374-17 Gardner Bone Chisel  
17 cm / 6 3/4" Fig A  
4mm Fig B  
All Tips: 4mm Fig C

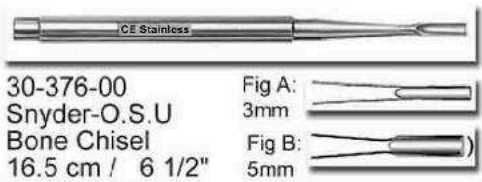

30-376-00 Snyder-O.S.U Bone Chisel  
16.5 cm / 6 1/2" Fig A: 3mm  
3 mm / 5 mm Fig B: 5mm

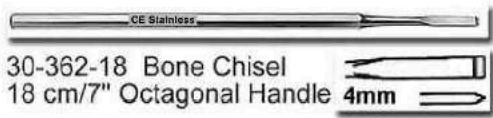

30-362-18 Bone Chisel  
18 cm / 7" Octagonal Handle 4mm



30-363-18A Bone Chisel  
18 cm / 7" Octagonal Handle 3mm

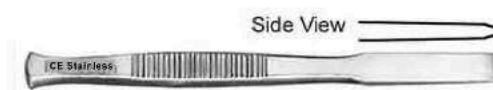

30-366-13 Osteotome  
13.5 cm / 5 1/4" Side View  
Fig A: 8mm Fig B: 10mm Fig C: 12mm Fig D: 14mm Fig E: 16mm



30-370-13 Chisel  
13.5 cm / 5 1/4" Side View  
Fig A: 8mm Fig B: 10mm Fig C: 12mm Fig D: 14mm Fig E: 16mm



30-372-13 Gouge  
13.5 cm / 5 1/4" Side View  
Fig A: 8mm Fig B: 10mm Fig C: 12mm Fig D: 14mm Fig E: 16mm



30-375-00 Partsch Chisel  
13.5 cm / 5 1/4" & 17 cm / 6 3/4" Side View  
Fig A: 2mm Fig B: 3mm Fig C: 4mm Fig D: 5mm Fig E: 6mm

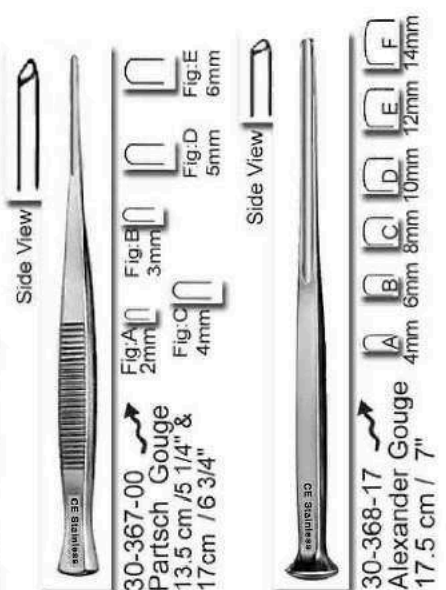

30-367-00 Partsch Gouge  
13.5 cm / 5 1/4" & 17 cm / 6 3/4" Side View  
Fig A: 2mm Fig B: 3mm Fig C: 4mm Fig D: 5mm Fig E: 6mm  
30-368-17 Alexander Gouge  
17.5 cm / 7" Side View  
Fig A: 4mm Fig B: 6mm Fig C: 8mm Fig D: 10mm Fig E: 12mm Fig F: 14mm

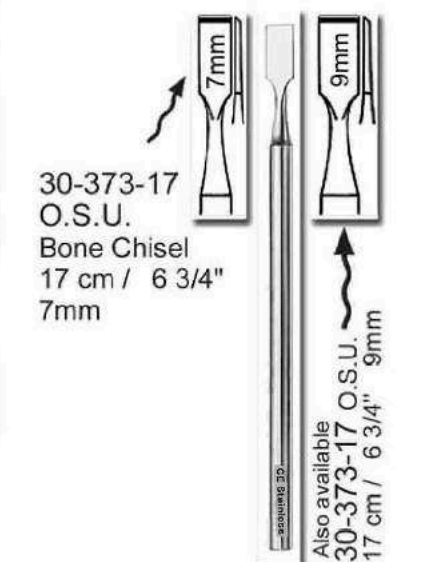

30-373-17 O.S.U. Bone Chisel  
17 cm / 6 3/4" 7mm  
Also available 30-373-17 O.S.U. 9mm  
17 cm / 6 3/4"

**TIP**

Side View Curved Tip

Three sizes in Lambotte Mini Osteotome (see below)

Available Tip Sizes: 2mm / 3mm / 4mm / 6mm / 8mm / 10mm / 12mm / 15mm

Side View

30-377-12 (12.5 cm / 5") Lambotte, Mini Osteotome

30-377-17 (17 cm / 6 3/4") Lambotte, Mini Osteotome  
3mm / 4mm / 6mm / 8mm / 10mm / 12mm / 15mm

30-377-24 (24 cm / 9 1/2") Lambotte, Osteotome  
15mm / 20mm / 25mm / 30mm / 38mm / 44mm / 50mm

Available in: 15mm, 20mm, 25mm, 30mm, 38mm, 44mm, 50mm

30-378-24 Lambotte, Osteotome  
24 cm / 9 1/2"

**Other Lambotte Mini Osteotomes sizes / Tips**

For Image, please see photo of above Osteotome.

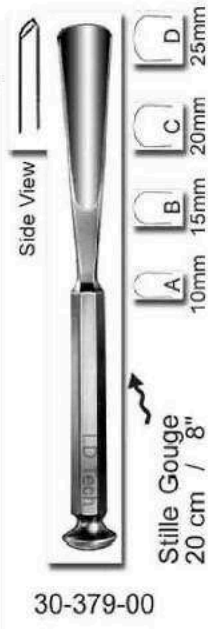

30-379-00 Stille Gouge  
20 cm / 8" Side View  
Fig A: 10mm Fig B: 15mm Fig C: 20mm Fig D: 25mm

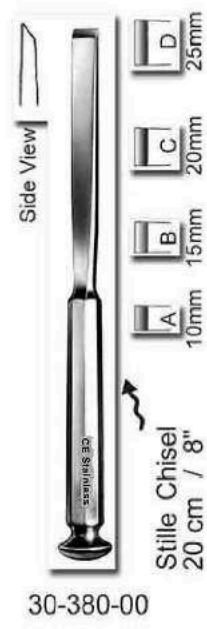

30-380-00 Stille Chisel  
20 cm / 8" Side View  
Fig A: 10mm Fig B: 15mm Fig C: 20mm Fig D: 25mm

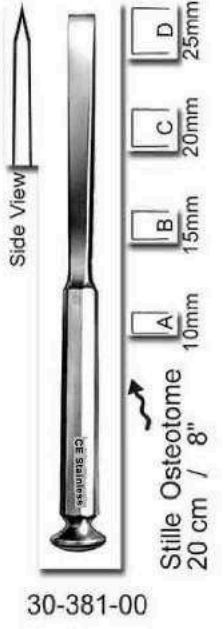

30-381-00 Stille Osteotome  
20 cm / 8" Side View  
Fig A: 10mm Fig B: 15mm Fig C: 20mm Fig D: 25mm

# CHISELS - GOUGES - OSTEOTOMES

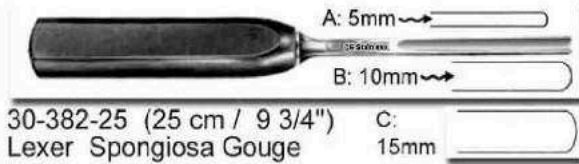

30-382-25 (25 cm / 9 3/4")  
Lexer Spongiosa Gouge

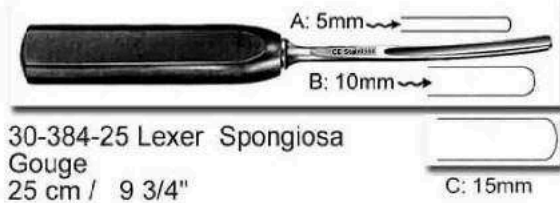

30-384-25 Lexer Spongiosa  
Gouge  
25 cm / 9 3/4"

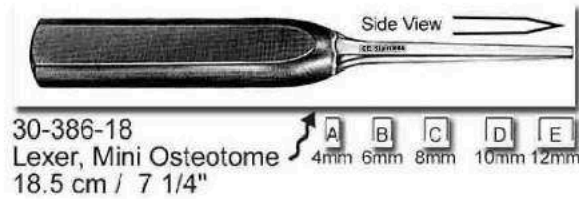

30-386-18  
Lexer, Mini Osteotome  
18.5 cm / 7 1/4"

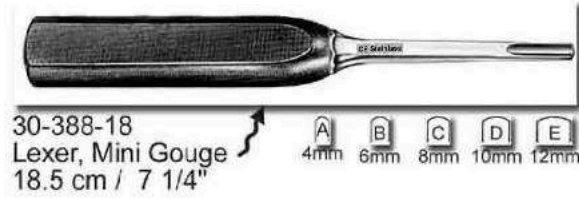

30-388-18  
Lexer, Mini Gouge  
18.5 cm / 7 1/4"

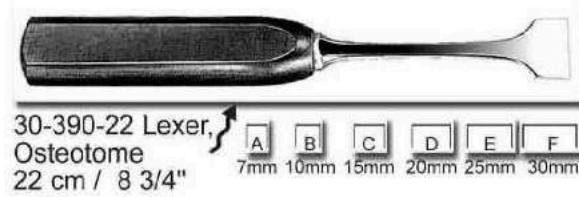

30-390-22 Lexer,  
Osteotome  
22 cm / 8 3/4"

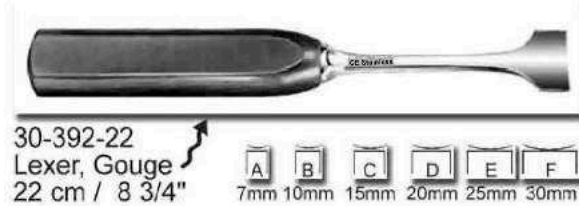

30-392-22  
Lexer, Gouge  
22 cm / 8 3/4"



30-394-18  
Vickers Spongiosa Gouge  
18 cm / 7"



30-397-18 US Army Chisel 18 cm / 7"

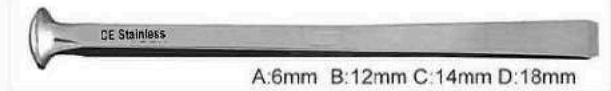

30-399-18 US Army Osteotome 18 cm / 7"



A: 6mm B: 12mm C: 14mm D: 18mm



30-383-20  
Smith-  
Petersen  
Osteotome  
20.5 cm / 8"

Available Tips  
6mm  
9mm  
13mm  
16mm  
19mm  
25mm  
32mm

TIP

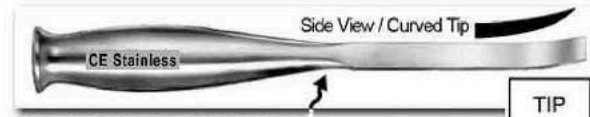

30-385-20 Smith-Petersen  
Osteotome  
20.5 cm / 8"

6mm / 9mm / 13mm /  
16mm / 19mm / 25mm / 32mm

TIP

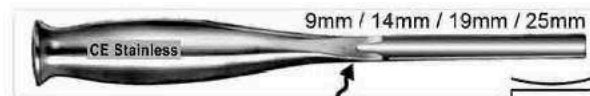

30-387-20 Smith-Petersen Gouge  
20.5 cm / 8"

TIP

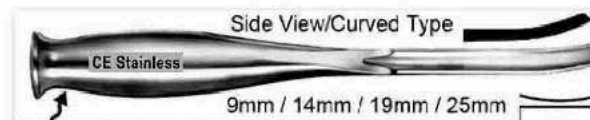

30-389-20 Smith-Petersen Gouge  
20.5 cm / 8"

9mm / 14mm / 19mm / 25mm

TIP



30-391-17 Hoke Osteotome  
17 cm / 6 3/4"

3mm / 5mm /  
6mm / 8mm / 9mm

TIP



30-393-24 Hibbs Osteotome  
24.5 cm / 9 3/4"

6mm / 13mm / 19mm / 25mm / 32mm

TIP



30-395-24 Hibbs Chisel  
24.5 cm / 9 3/4"

6mm / 13mm / 19mm / 25mm / 32mm

TIP



30-396-24 Hibbs Gouge  
24.5 cm / 9 3/4"

6mm / 13mm / 19mm / 25mm / 32mm

TIP



30-398-16 Sheehan Osteotome 16cm / 6 1/2"

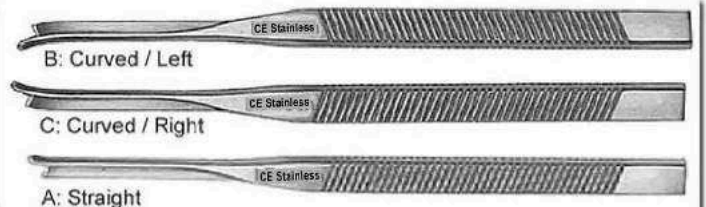

30-401-10 Oiler Osteotome 10 cm / 4"



# CHISELS - GOUGES - OSTEOTOMES

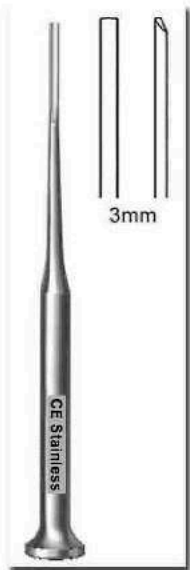

30-402-21  
Shoulder Penetrating  
Gouge 21cm/8 1/2"

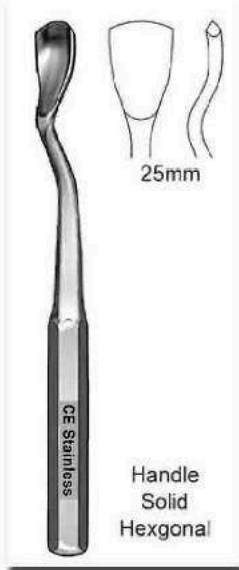

30-403-23  
Swan Neck  
Gouge 23cm/9"

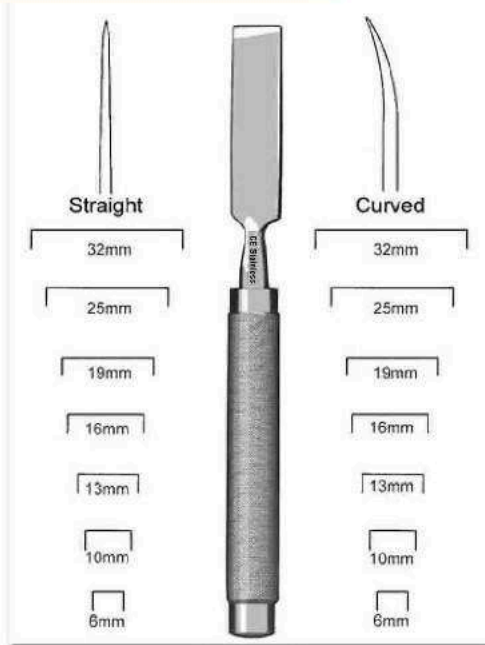

30-404-00  
Cobb Osteotome 28cm/11"

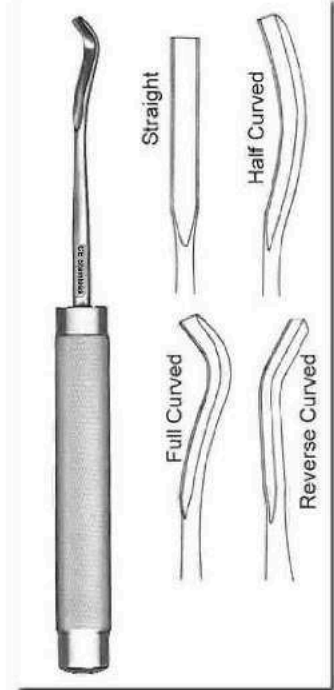

30-405-00  
Cobb Gouge 28cm/11"

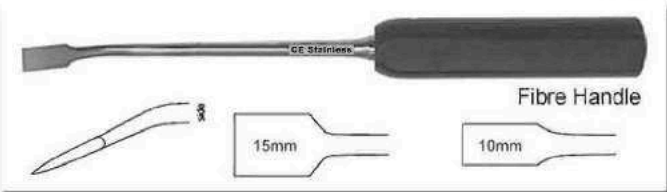

30-406-00 Lexter Osteotome Angled / 28cm/11"



30-407-00 Cinelli Osteotome 15.5cm/6 1/2"

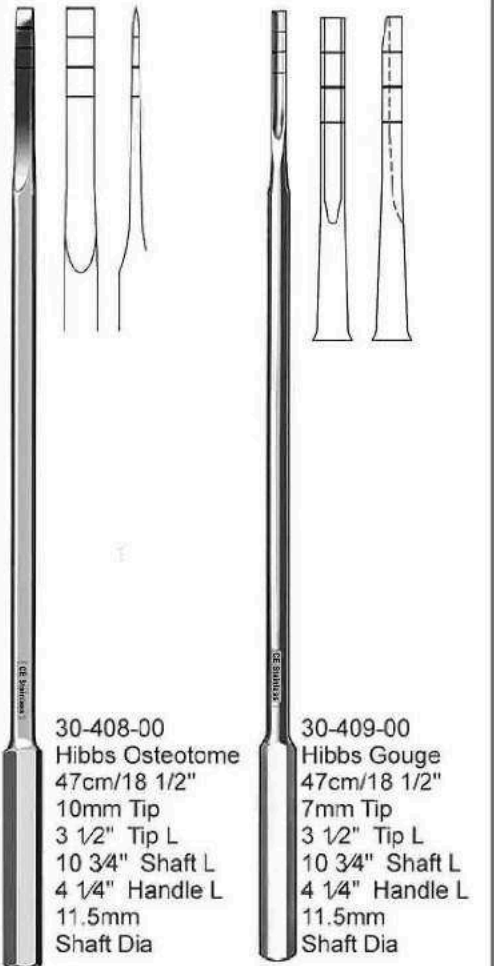

30-408-00  
Hibbs Osteotome  
47cm/18 1/2"  
10mm Tip  
3 1/2" Tip L  
10 3/4" Shaft L  
4 1/4" Handle L  
11.5mm  
Shaft Dia

30-409-00  
Hibbs Gouge  
47cm/18 1/2"  
7mm Tip  
3 1/2" Tip L  
10 3/4" Shaft L  
4 1/4" Handle L  
11.5mm  
Shaft Dia



30-410-24  
Spinal Fusion  
Gouge  
24cm/9 1/2"  
6mm Tip

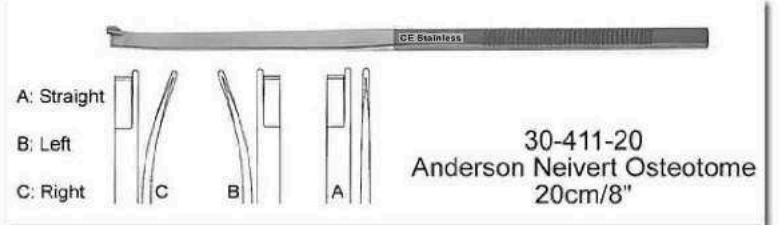

30-411-20  
Anderson Neivert Osteotome  
20cm/8"

Key

Chisels

Osteotome

Gouge

Set Includes:  
5 Chisels  
5/10/15/25mm  
5 Osteotomes  
5/10/15/25mm  
3 Gouges  
50/60/70mm Radius  
1 Handle Fibre  
1 Key

I.D Tech

30-412-18  
Chisel Handle Fibre w/Chisel - Osteotome - Gouge Blades  
18.5cm/7 1/4"

# BONE CURETTES

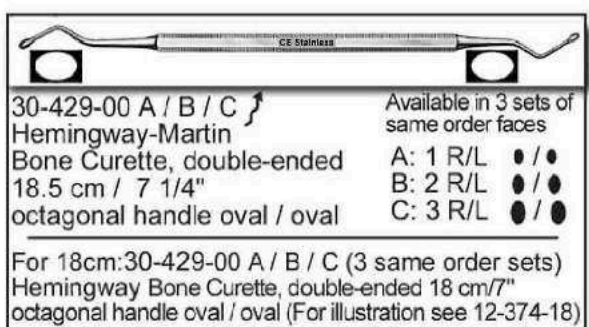
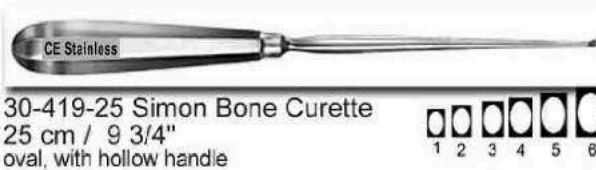
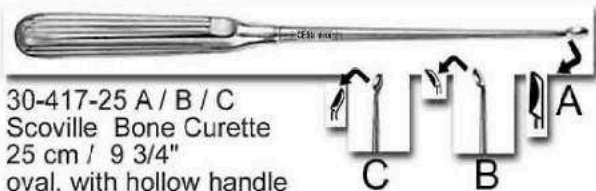
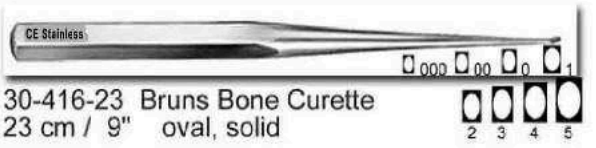
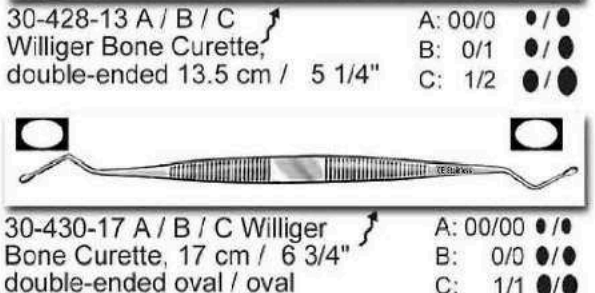
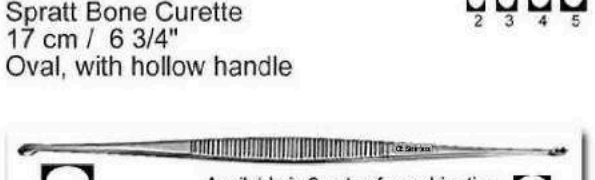
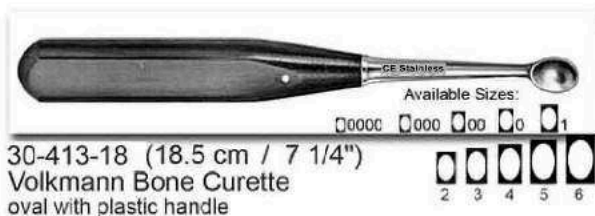

# BONE CURETTES

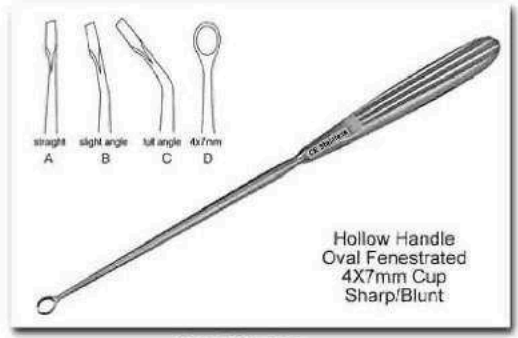
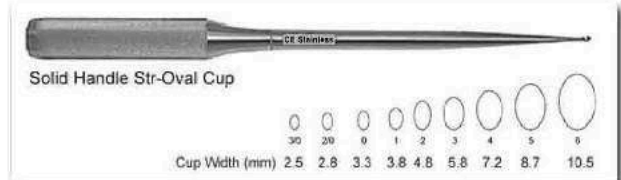
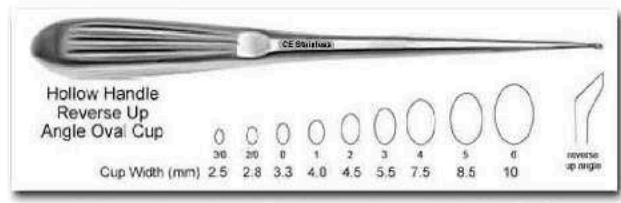
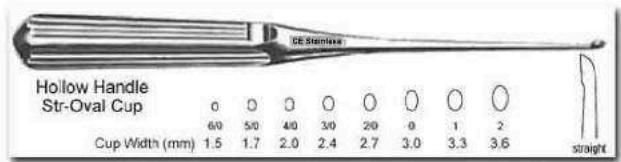
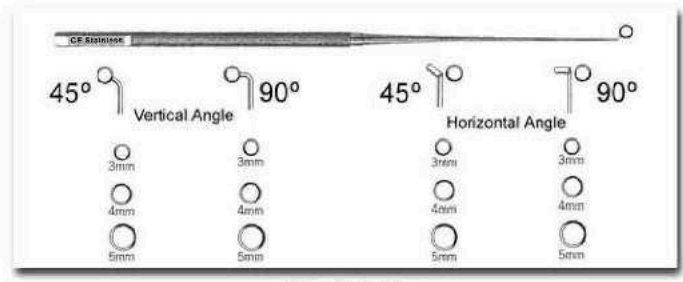
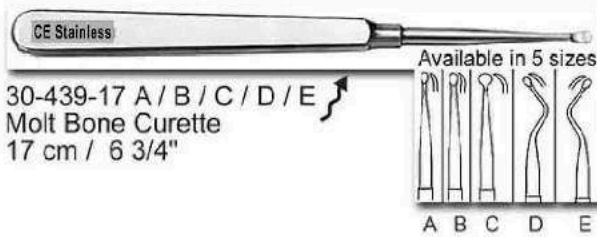
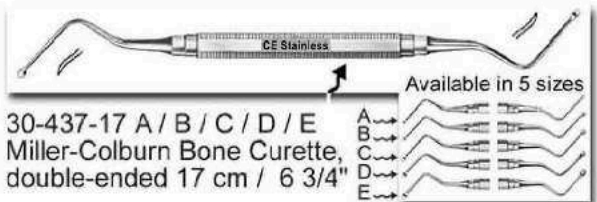
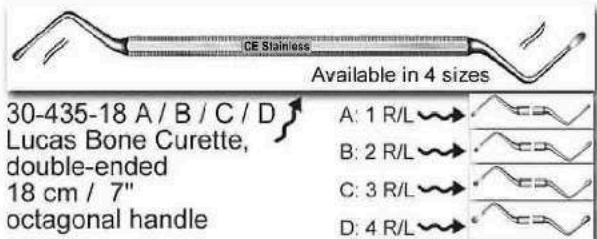
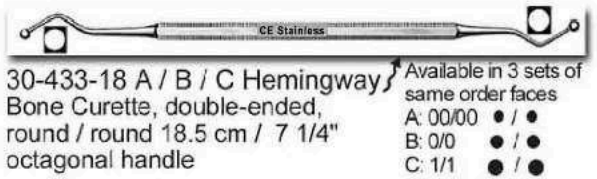
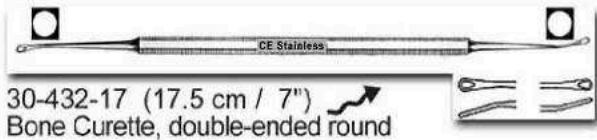

A: 25 cm / 10" #0 6mm Cup  
B: 25 cm / 10" #2 8mm Cup  
C: 26 cm / 10 1/2" #6 14mm Cup  
D: 28 cm / 11 1/2" #0 6mm Cup  
E: 28 cm / 11 1/2" #2 8mm Cup  
F: 30 cm / 12 1/2" #6 14mm Cup

# BONE CURETTES

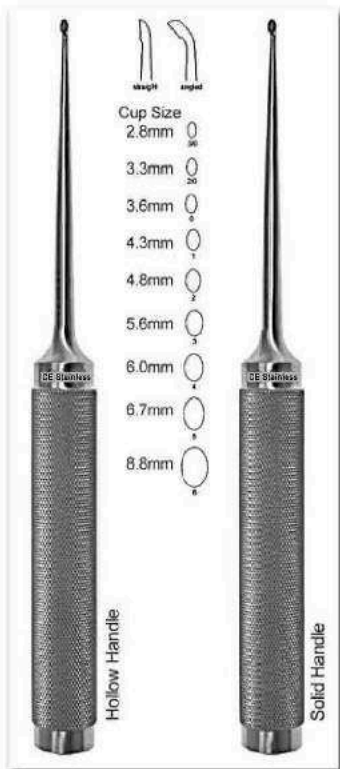

30-446-28  
Cobb Curette Oval Cups  
28 cm / 11"



30-447-28  
Cobb Curette Oval Cups  
28 cm / 11"

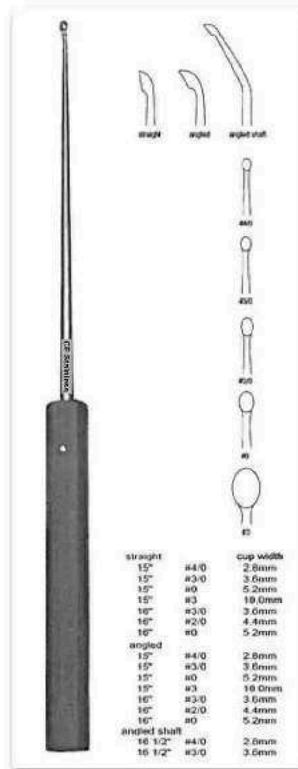

30-448-00  
Sypert Curette Long Delicate Shaft

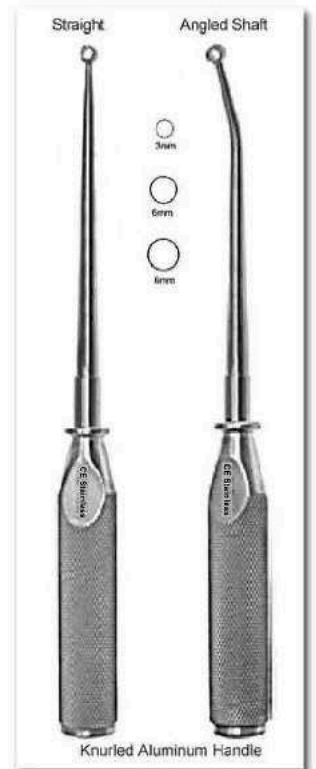

30-449-23  
Cone Ring Curette  
23 cm / 9"



- A: Straight 8mm Sharp/Blunt
- B: Straight 11mm Sharp/Blunt
- C: Angled 8mm Sharp/Sharp
- D: Angled 11mm Sharp/Sharp
- E: Angled 8mm Sharp/Sharp Right Cvd
- F: Angled 11mm Sharp/Sharp Right Cvd
- G: Angled 8mm Sharp/Sharp Left Cvd
- H: Angled 11mm Sharp/Sharp Left Cvd

30-450-00 Zielke Ring Curette 34 cm / 13 1/2" TEFLON Handle

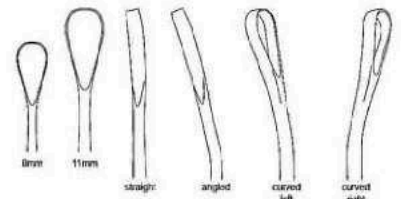

17" Angled 40°  
3mm Diameter  
2.7" Tip Length  
9.3" Shaft Length  
5" Handle Length  
.285 (7.2mm)  
Shaft Diameter



30-451-00 Cone Ring Curette Endoscopic Fibre Handle

20" Angled 30°  
6mm Diameter  
3 1/2" Tip Length  
10" Shaft Length  
6 1/2" Handle Length  
.45" (11.5mm)  
Shaft Diameter

17" Reverse  
Angled 40°  
3mm x 6mm cup  
2.7" Tip Length  
9.3" Shaft Length  
5" Handle Length  
.285 (7.2mm)  
Shaft Diameter



30-452-00 Epstein Curette Endoscopic Fibre Handle

20" Reverse  
Angled 30°  
6mm x 9mm cup  
3 1/2" Tip Length  
10" Shaft Length  
6 1/2" Handle Length  
.45 (7.2mm)  
Shaft Diameter

# ELEVATORS

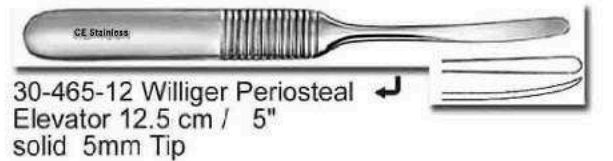
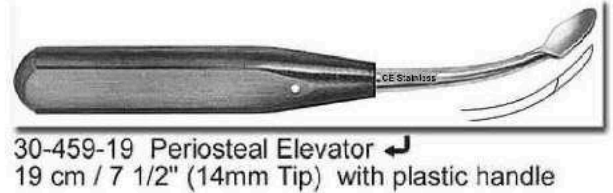
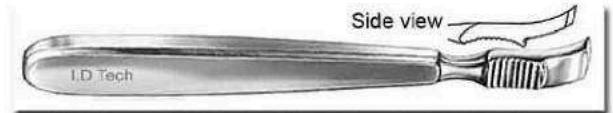
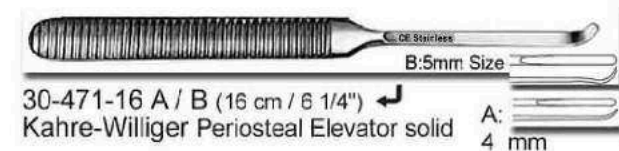
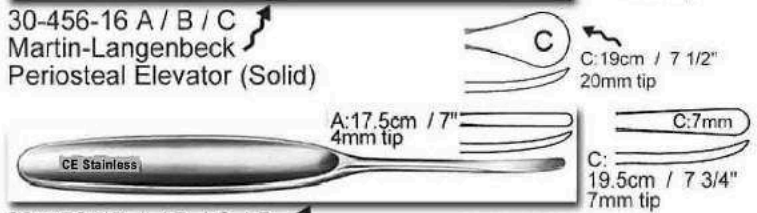
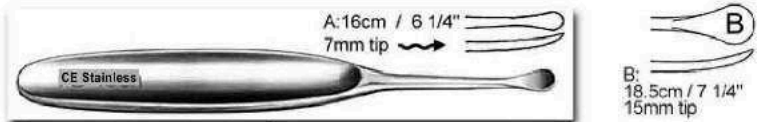
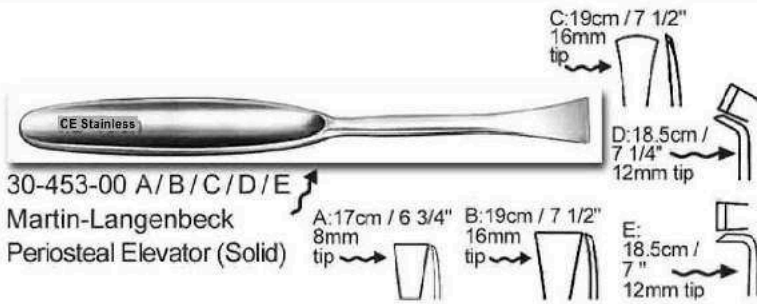

# ELEVATORS

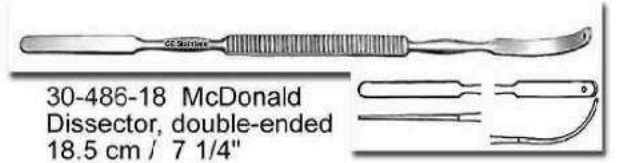
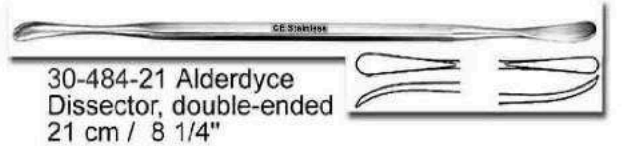
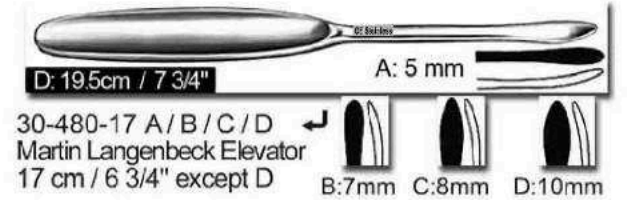
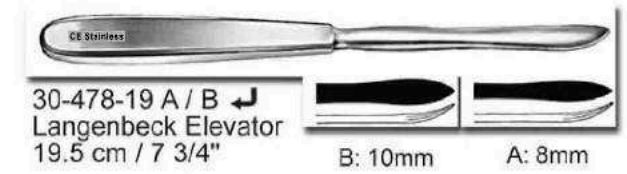
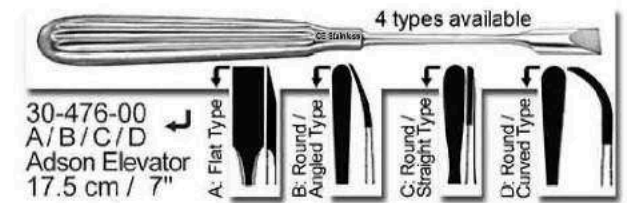
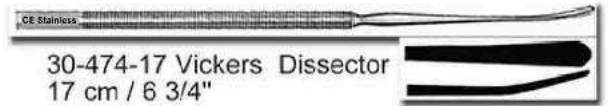
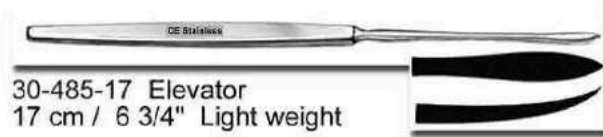
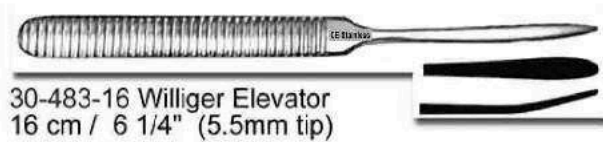
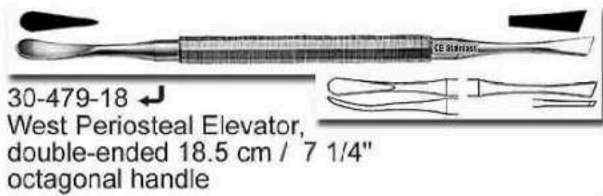
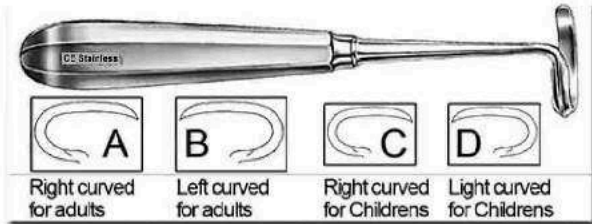
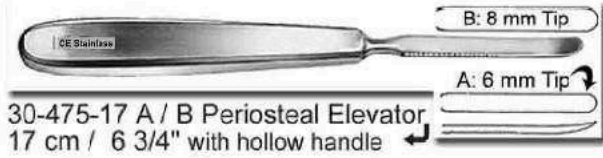
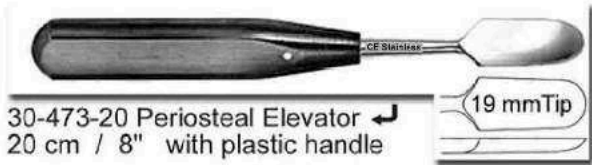

# ELEVATORS

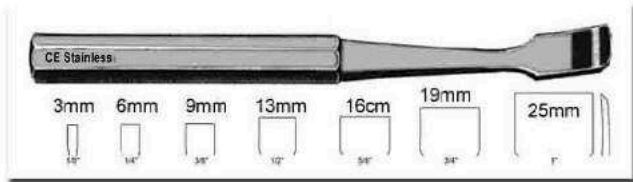

30-492-19 Key Elevator 19 cm / 7 1/2" Sharp Edge



30-493-16 Sayre Elevator 16 cm / 6 1/2"  
A: Sharp / Blunt B: Blunt/ Blunt

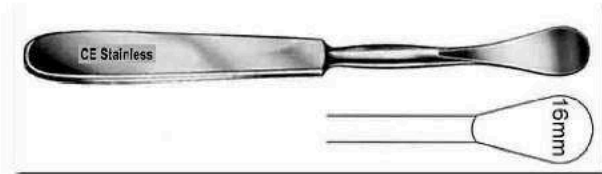

30-494-18 Sedilot Elevator 18 cm / 7" Sharp Edge

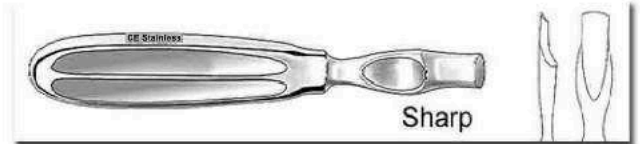

30-495-17 Kirmission Periosteal Respiratory 17 cm / 6 3/4"



30-496-20 Alexander Periosteal Respiratory  
20 cm / 8" / 12mm Sharp



30-497-17 Periosteal Elevator  
17 cm / 6 3/4"  
Fibre Handle 13mm Blade Sharp

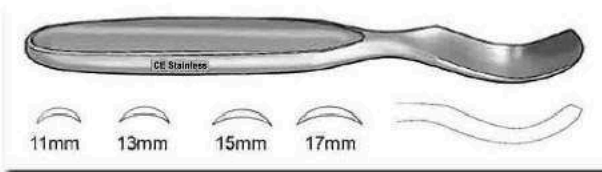

30-498-16 McGlamry Metatarsal Elevator  
16 cm / 6 1/2" Sharp



30-499-19 Crego Periosteal Elevator  
19 cm / 7 3/4" Sharp

A: 14mm Full Curves B: 14mm Slight Curves  
C: 7mm Full Curves D: 7mm Slight Curves

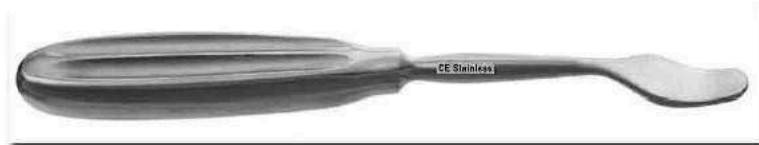
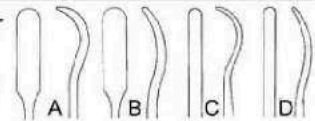

30-500-00 Chandler Elevator Blunt

A: 19cm / 7 1/2" 13mm B: 20cm / 8" 19mm  
C: 23cm / 9" 25mm D: 25.5cm / 10" 30mm

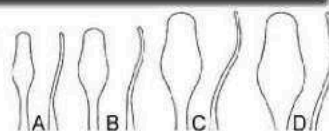

30-501-00 Darrach Elevator Blunt

Small  
A: 26cm / 10 1/4" 13mm Width at Tip  
Medium  
B: 26cm / 10 1/4" 20mm Width at Tip  
Large  
C: 35cm / 13 3/4" 25mm Width at Tip

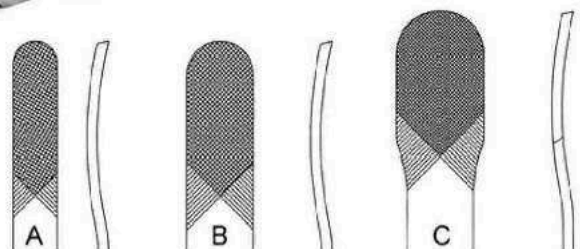

# ELEVATORS

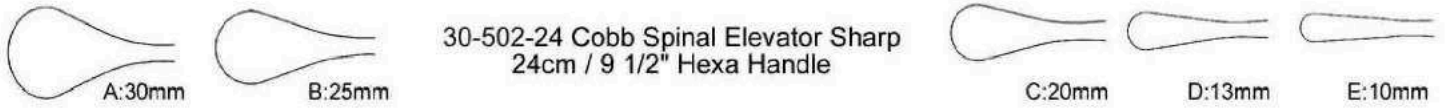
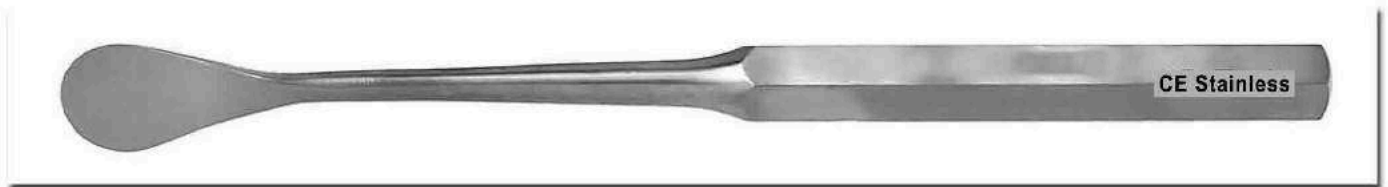

30-502-24 Cobb Spinal Elevator Sharp  
24cm / 9 1/2" Hexa Handle



←  
Also Available  
in Fibre Handle

with Same  
Sizes  
of Blades

30-503-25  
25cm / 10"

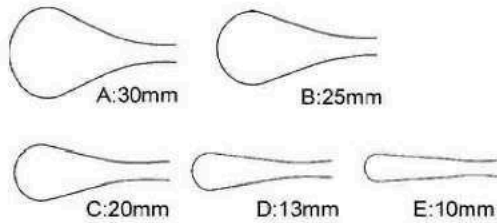

30-504-28 Cobb Spinal Elevator Sharp  
28cm / 11" Knurled Handle



30-505-00 Cobb Elevator Endoscopic Sharp / Fibre Handle



A	B	C	D
A: 43cm / 17"	B: 50cm / 20"	C: 50cm / 20"	D: 50cm / 20"
6mm Tip Width	6mm Tip Width	10mm Tip Width	13mm Tip Width
2.7" Tip Length	3 1/2" Tip Length	3 1/2" Tip Length	3 1/2" Tip Length
9.3" Shaft Length	10" Shaft Length	10" Shaft Length	10" Shaft Length
5" Handle Length	6 1/2" Handle L	6 1/2" Handle L	6 1/2" Handle L
7.2mm Shaft Dia	11.5mm Shaft Dia	11.5mm Shaft Dia	11.5mm Shaft Dia



30-506-43 Rib Elevator Endoscopic Sharp / Fibre Handle  
43cm / 17" - 9mm Tip Radius - 4" Tip Length  
8" Shaft Length - 5" Handle Length  
11.5mm Shaft Dia

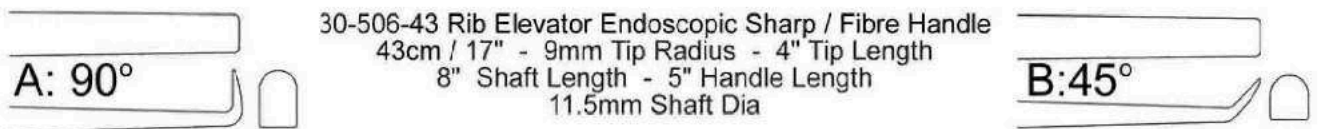

30-507-33 Wagner Elevator Sharp / Fibre Handle  
33cm / 13"  
A: 8mm Wide B: 17mm Wide

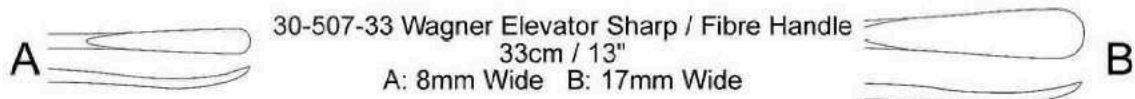



# BONE MALLET

**Note: Handle Shown In Dark Colors are Made of FIBRE Material**

30-509-19 Lucae Mallet 19.5cm / 7 3/4"  
  
 CE Stainless  
 Available in 2 sizes  
 19mm Ø / 230 gms  
 25mm Ø / 260 gms

30-510-19 Cottle Mallet Plane / Convex  
  
 CE Stainless  
 19cm / 7 1/2" 30mm Ø / 300 gms

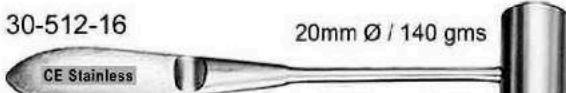
30-512-16 Williger Mallet  
  
 CE Stainless  
 20mm Ø / 140 gms  
 16.4cm / 6 1/2"

30-514-26 Mallet 26 cm / 10 1/4"  
  
 CE Stainless  
 30mm Ø / 510 gms

30-516-19 Mead Mallet  
  
 CE Stainless  
 19 cm / 7 1/2"  
 27mm Ø / 320 gms  
 with interchangeable plastic disks

30-518-19 Partsch Mallet  
  
 CE Stainless  
 22mm Ø / 200 gms  
 19 cm / 7 1/2" with hollow handle

30-520-26 Mallet 26 cm / 10 1/4"  
  
 with lead filling  
 Also available without lead filling  
 42mm Ø / 400 gms

30-521-26 Mallet  
  
 26 cm / 10 1/4"  
 without lead filling  
 42mm Ø / 400 gms

30-523-24 Williger Mallet  
  
 CE Stainless  
 24 cm / 9 1/2" lead filled  
 Available Head Sizes & Approximate Weight  
 26mm Ø / 300 gms  
 28mm Ø / 340 gms  
 30mm Ø / 400 gms

30-508-26 Mallet 26.5 cm / 10 1/2"  
  
 30mm Ø / 675 gms  
 plane (Teflon) / convex (steel)

30-511-26 Mallet 26 cm / 10 1/4"  
  
 42 / 30mm Ø / 530 gms

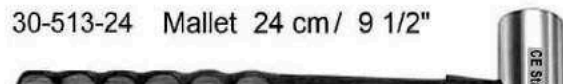
30-513-24 Mallet 24 cm / 9 1/2"  
  
 CE Stainless  
 30mm Ø / 480 gms

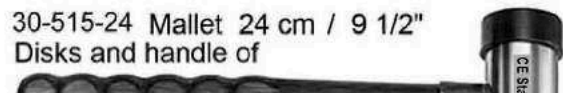
30-515-24 Mallet 24 cm / 9 1/2"  
  
 Disks and handle of  
 37mm Ø / 370 gms  
 Spare facings (Pair)

30-517-22 Mallet 22 cm / 8 3/4"  
  
 30mm Ø / 125 gms

30-519-26 Mallet 26.5 cm / 10 1/2"  
  
 CE Stainless  
 30mm Ø / 450 gms

30-522-00 A/B/C Doyen Mallet  
  
 CE Stainless  
 Available Length / Head Sizes & Approximate Weight  
 A: 20.5cm / 8" 25mm Ø / 120 gms  
 B: 21cm / 8 1/4" 30mm Ø / 180 gms  
 C: 21.5cm / 8 1/2" 35mm Ø / 260 gms

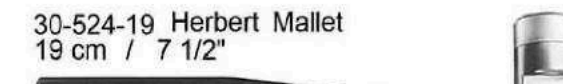
30-524-19 Herbert Mallet 19 cm / 7 1/2"  
  
 CE Stainless  
 for ulnar head prosthesis

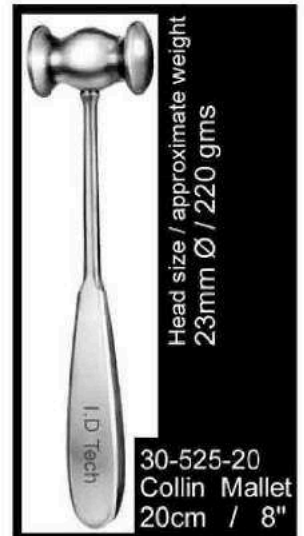
30-525-20 Collin Mallet 20cm / 8"  
  
 Head size / approximate weight  
 23mm Ø / 220 gms

30-526-26 Mallet 26.5 cm / 10 1/2"  
  
 CE Stainless  
 50mm Ø / 900 gms

30-527-19 Vickers Mallet 19 cm / 7 1/2"  
  
 CE Stainless  
 25mm Ø / 300 gms  
 Teflon disks

# BONE MALLET

**Note: Handle Shown In Dark Colors are Made of FIBRE Material**



30-528-20  
Kirk Mallet 20cm / 8"  
Head Dia 38mm/Weight:1 lb. 4 oz. (570 grams)



Head Weight: 7 oz (200 grams)

30-529-19 Gerzog Mallet 19cm / 7 1/2"  
Head Dia 25mm/Weight 10 oz (285 grams)



Head Weight: 20 oz (567 grams)

30-530-19 Heath Mallet  
19cm / 7 1/2"  
Head Dia 40mm/Weight 2 lbs. (907gm)

Head Weight: 20 oz (567 grams)



30-533-18 Heath Mallet, SS  
18cm / 7" Solid Frame Handle  
Head Dia 40mm/Weight 36 oz. (1020gm)



30-536-24 All Fibre Mallet 24cm / 9 1/2"  
Head Dia 80X60mm Weight 14oz. (397gm)



Fibre Handle

30-531-19  
Cloward Mallet  
19cm / 7 1/2"  
Head Dia 20mm  
Weight 8oz. (227gm)



30-532-20  
Hajek Mallet  
20cm / 8"  
Head Dia 27mm  
Weight 7oz. (198gm)

Fibre Handle



30-534-20 Narrow Tip Mallet 20cm / 8"  
Head Dia 7mm Weight 6oz. (170gm)



30-535-23 Fibre Handle Mallet 23cm / 9"  
Head Dia 30mm/Weight 12 oz. (340gm)  
Also Available in:  
Head Dia 35mm/Weight 1lb 40 oz. (570gm)  
Head Dia 40mm/Weight 1lb 90 oz. (708gm)



30-537-28 He-Man Mallet 28cm / 11"  
Head Dia 38mm / 24mm  
Weight 2lb (906gm)

# TENDON - CARTILAGE - MENISCUS TOOLS

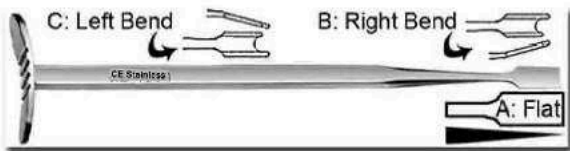

30-538-18 Smillie Meniscus Knife 18 cm / 7"



30-539-18 Meniscus Knife 18 cm / 7"



30-540-22 A / B  
Neff Meniscus Knife 22 cm / 8 3/4"



30-541-21 A / B Salenius Meniscus Knife  
21 cm / 8 1/4"      A: Right / B: Left



30-542-15 Bunnell Tendon Stripper 15 cm / 6"  
3mm 4mm 5mm 6mm 7mm

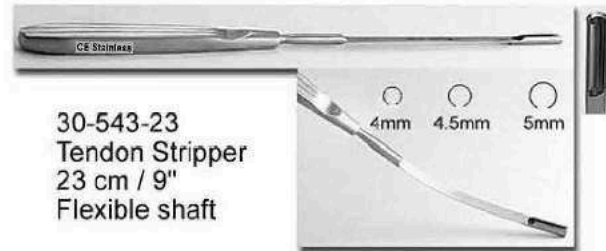

30-543-23  
Tendon Stripper  
23 cm / 9"  
Flexible shaft



30-544-33 Tendon Passing Instrument 33.5 cm / 13 1/4"



30-545-31 Fischer Tendon Stripper 31 cm / 12 1/4" Blunt

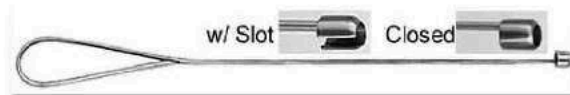

30-546-28 Tendon Stripper 3 / 4 / 5 / 6mm  
A: 28.5 cm / 11 1/4"      B: 60 cm / 24"



30-547-23 Bunnell Tendon Passer 23 cm / 9" Malleable



30-548-40 Tendon Stripper 40 cm / 16"  
Fibre Handle



30-549-25  
Lowe Breck  
Cartilage Knife  
25 cm / 10"  
Str Edge-Cvd Blade  
w/ Guards

30-550-25  
Downing  
Cartilage Knife  
25 cm / 10"  
Concave Edge  
Cvd Blade  
w/ Guards



30-551-20 Martin Cartilage Scissors 20cm / 8"

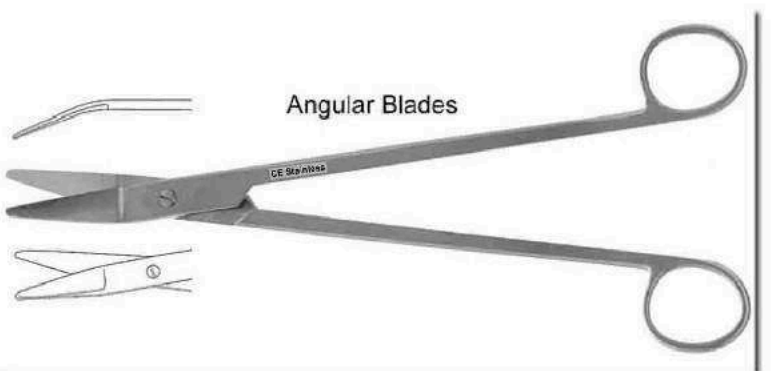

30-552-24 Mueller Capsule Scissors 24cm / 9 1/2"

# TENDON INSTRUMENTS

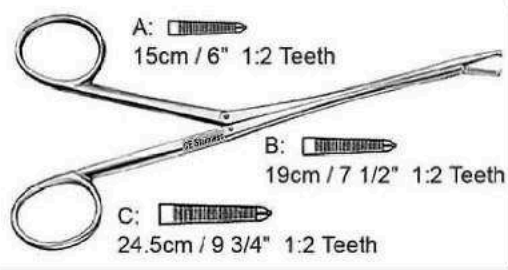
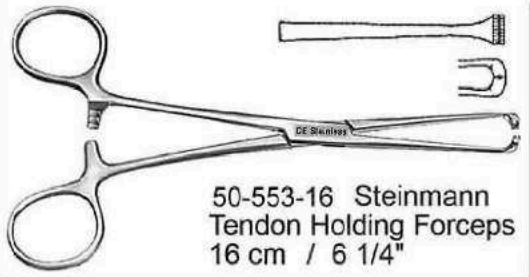

30-554-00 A / B / C  
Brand Tendon Tunnelling Forceps

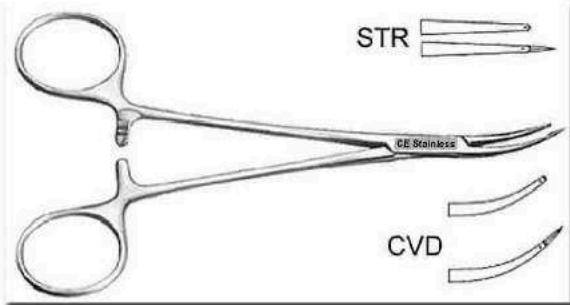
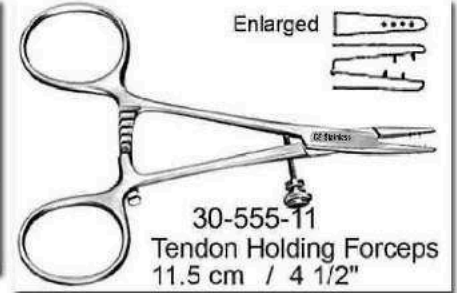

30-556-15 Tendon Interlacing Forceps  
15.5 cm / 6" Pointed

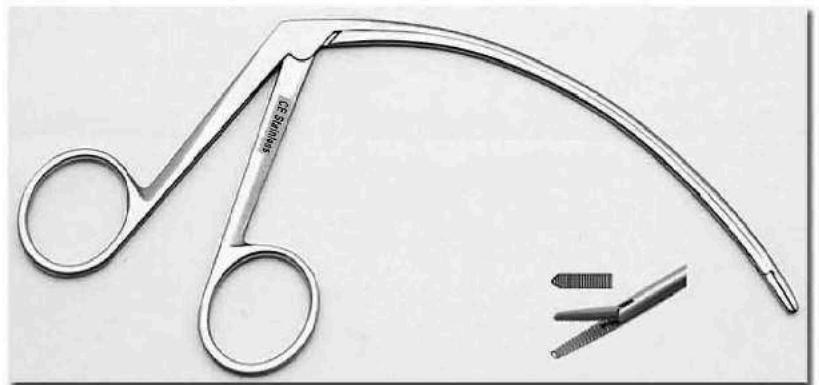

30-557-11  
Carroll Tendon Holding Forceps 11.5 cm / 4 1/2"

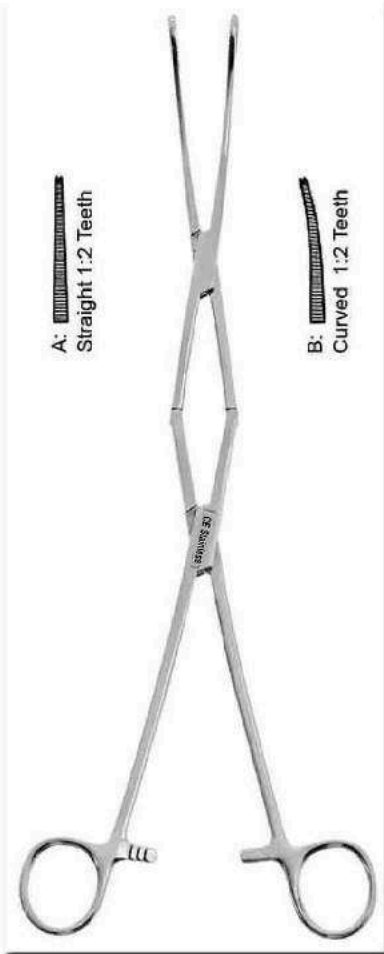

30-558-21  
Hallman Tendon Tunnelling Forceps  
21 cm / 8 1/4"

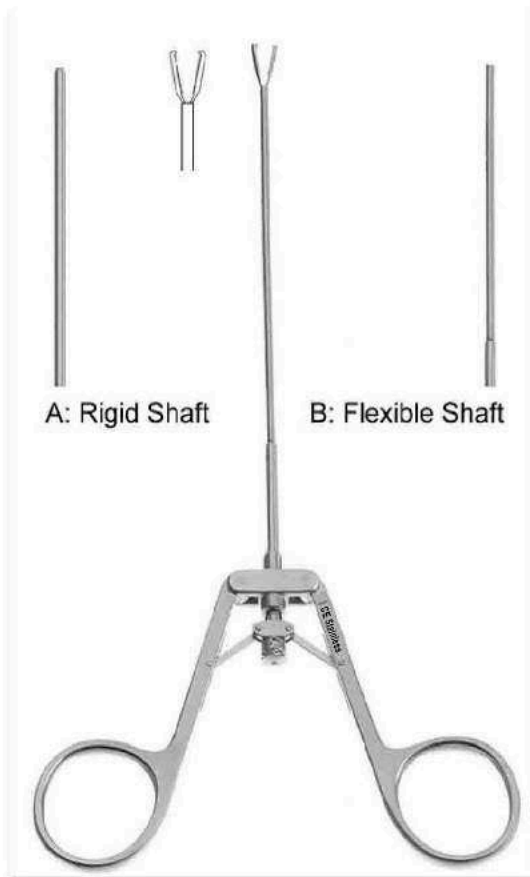

30-559-21  
Kleinert-Kutz Tendon Holding Forceps  
21 cm / 8 1/4" 1X2 teeth



30-560-14  
Hoen Grasping Forceps  
14 cm / 5 1/2" (Shaft)  
1X2 teeth

**BONE GRASPERS - MENISCUS CLAMPS**

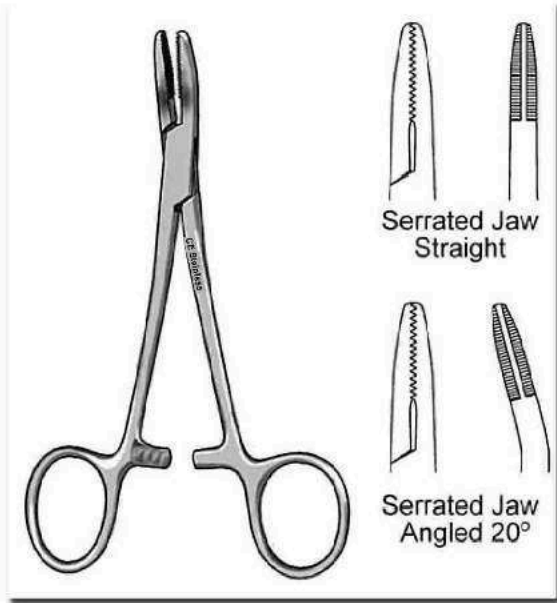

30-561-13  
Meniscus Clamp  
13.5 cm / 5 3/8" 1X2 teeth

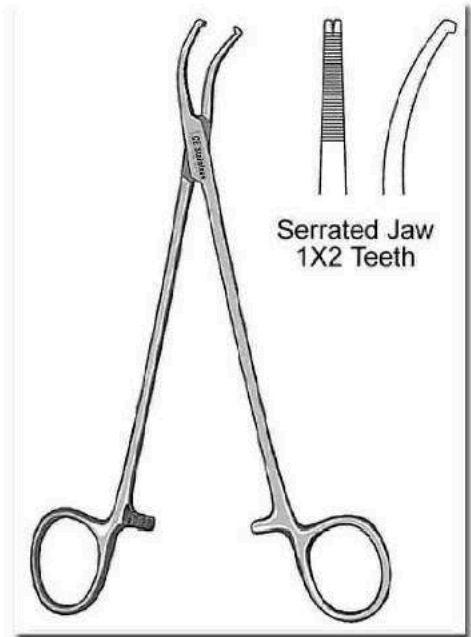

20-562-18  
Preston Ligamentum Flavum Forceps  
(Meniscus) 18.5 cm / 7 1/4"



Straight

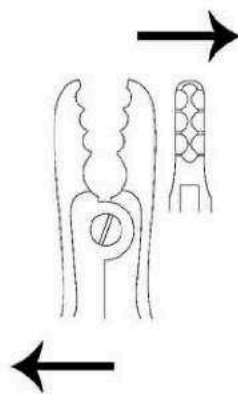

Angled

30-563-21  
Ortho Grasper 21 cm / 8 1/2"  
7 X 20 MM Bite

# PELVIC REDUCTION INSTRUMENTS

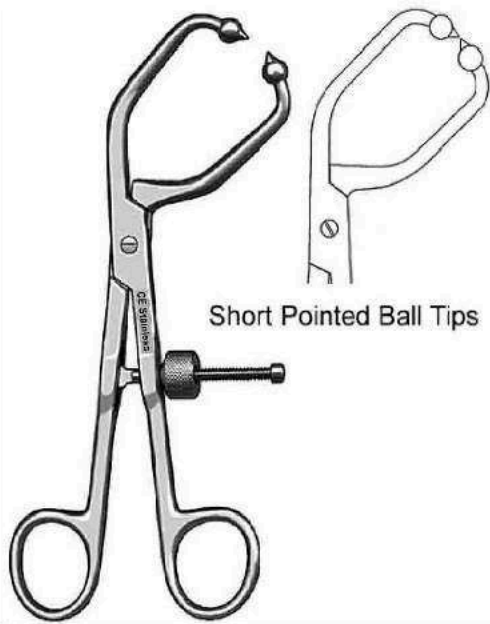

Short Pointed Ball Tips

30-564-19 Pelvic Reduction Forceps  
19 cm / 7 3/8" Angular

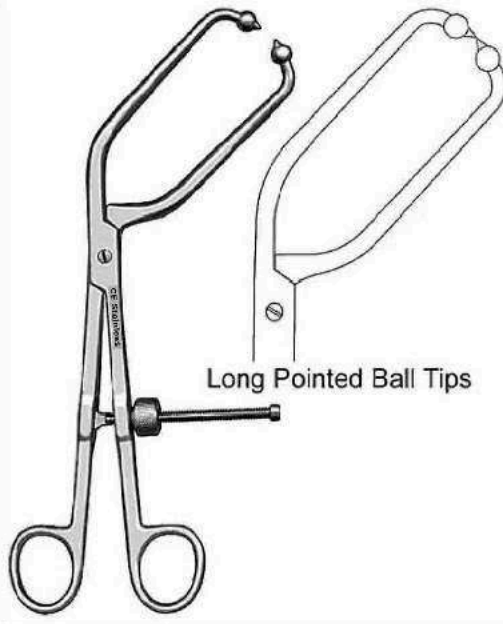

Long Pointed Ball Tips

30-565-24 Pelvic Reduction Forceps  
24.5 cm / 9 5/8" Angular

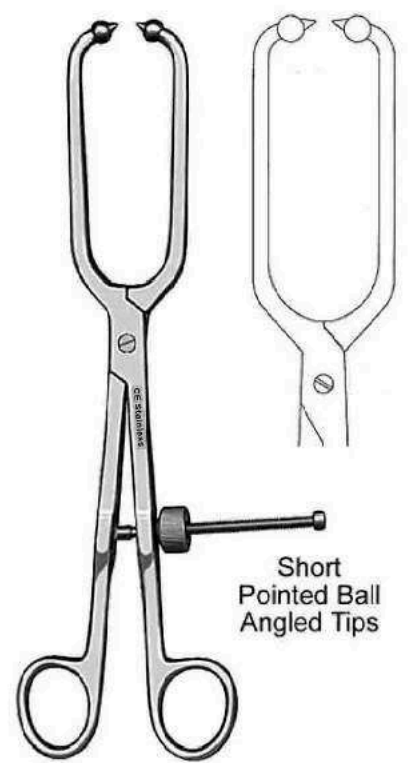

Short Pointed Ball Angled Tips

30-566-25 Pelvic Reduction Forceps  
25 cm / 10"



30-567-00 Pelvic Reduction Forceps

Available in 2 Sizes  
A: 24 cm / 9 1/2"  
B: 41 cm / 16"

Long Pointed Ball Tips

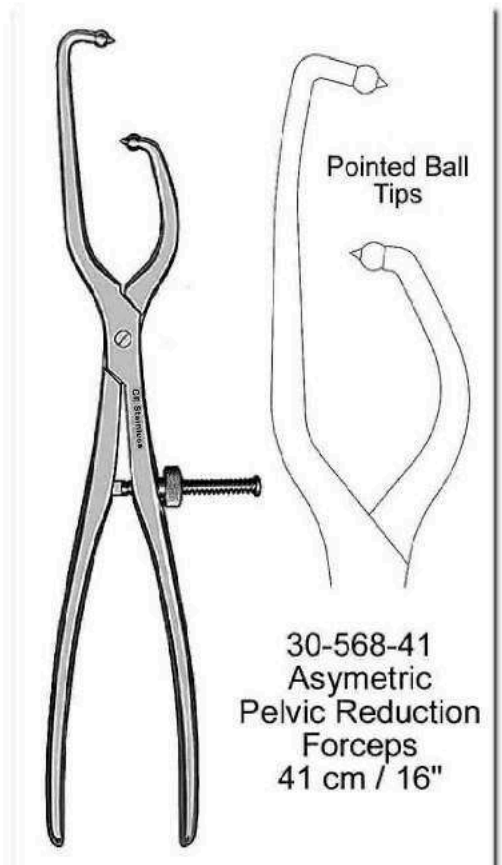

Pointed Ball Tips

30-568-41 Asymmetric Pelvic Reduction Forceps  
41 cm / 16"

# PELVIC REDUCTION INSTRUMENTS

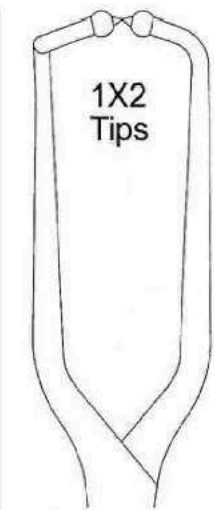

50-569-41  
Pelvic Reduction Forceps  
Long 1X2  
Pointed Ball Tips  
41 cm / 16"

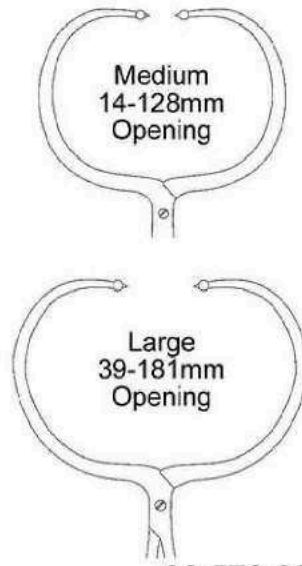

30-570-38  
Periarthral  
Reduction Forceps  
Straight  
Pointed Ball Tips  
38 cm / 15"



30-571-00  
Pelvic  
Reduction Forceps  
Adjustable Jaws for Screws  
A: 25 cm / 10"  
B: 33 cm / 13"

# BONE HOLDING FORCEPS



30-572-14  
Bone Holding Forceps  
14 cm / 5 1/2"

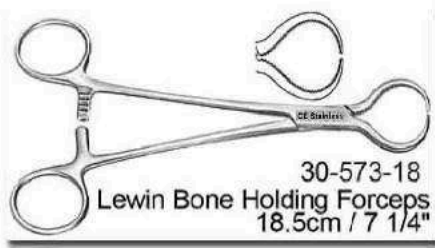

30-573-18  
Lewin Bone Holding Forceps  
18.5cm / 7 1/4"

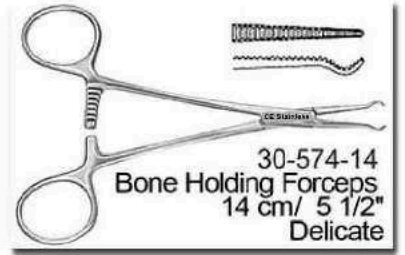

30-574-14  
Bone Holding Forceps  
14 cm / 5 1/2"  
Delicate



30-575-18 Frosch Bone  
Holding Forceps 18 cm / 7"



30-576-20 Bone Holding  
Forceps 20 cm / 8"



30-577-19 Semb Bone Holding  
Forceps 19 cm / 7 1/2"



30-578-21  
Langenbeck Bone  
Holding Forceps

21 cm / 8 1/4"

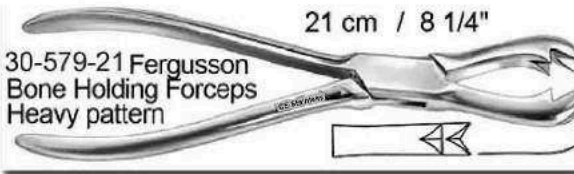

30-579-21 Fergusson  
Bone Holding Forceps  
Heavy pattern

21 cm / 8 1/4"

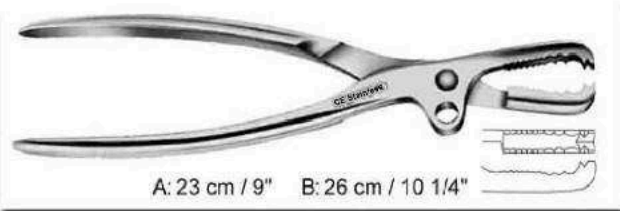

A: 23 cm / 9" B: 26 cm / 10 1/4"

30-580-00  
Farabeuf Bone Holding Forceps



30-582-00  
Kern Bone Holding Forceps  
A: 17 cm / 6 3/4"  
B: 21 cm / 8 1/4"



Holes in Handle

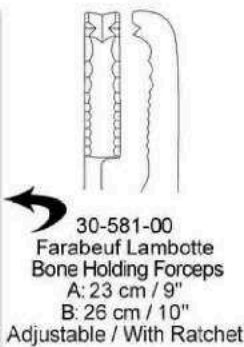

30-581-00  
Farabeuf Lambotte  
Bone Holding Forceps  
A: 23 cm / 9"  
B: 26 cm / 10"  
Adjustable / With Ratchet

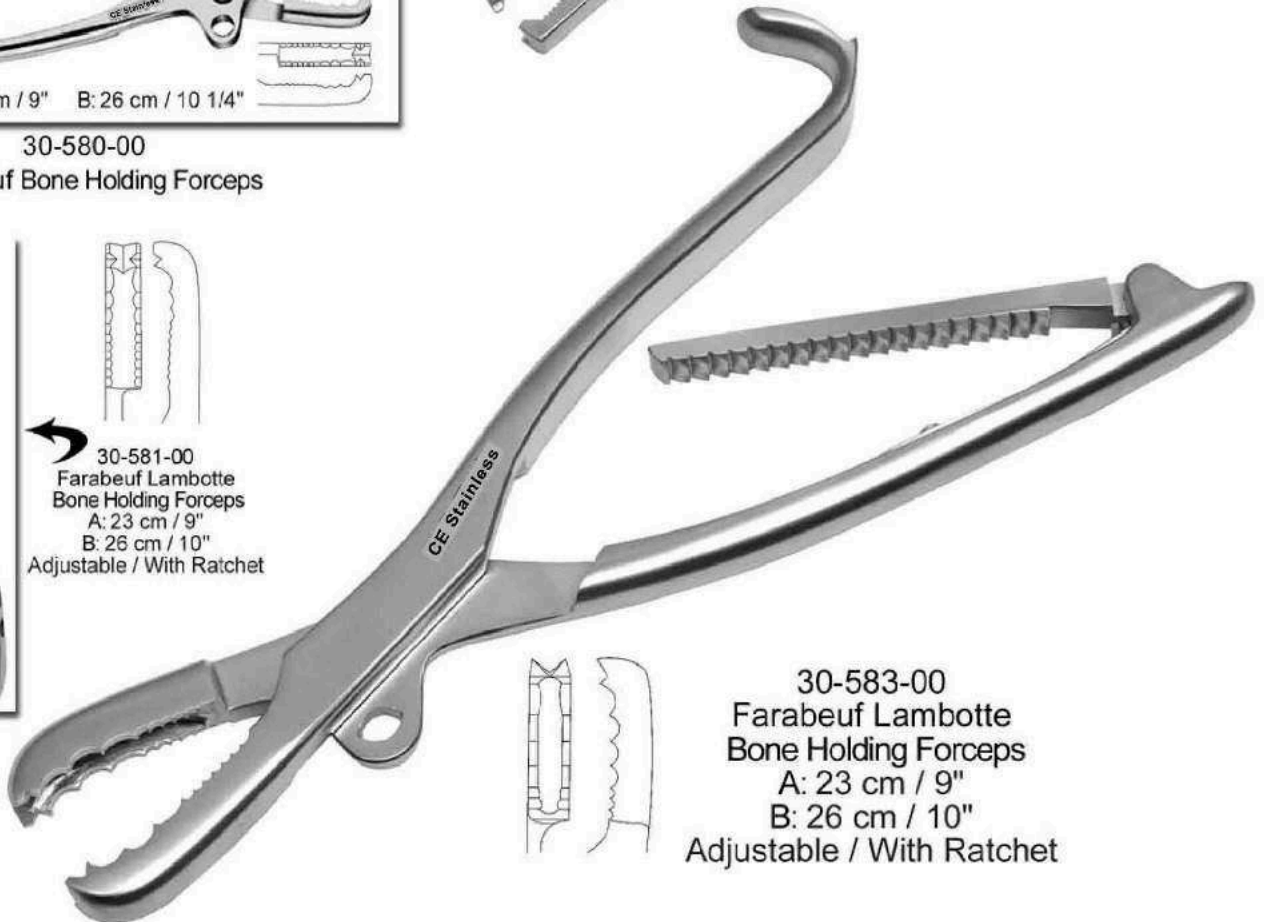

30-583-00  
Farabeuf Lambotte  
Bone Holding Forceps  
A: 23 cm / 9"  
B: 26 cm / 10"  
Adjustable / With Ratchet



# BONE HOLDING FORCEPS



30-584-00  
Lambotte Bone Holding Forceps  
w/ Swivel Head, Adjustable Jaw  
A: 22 cm / 8 3/4"  
A: 27 cm / 10 3/4"  
A: 30 cm / 11 3/4"



30-585-19  
Ulrich Bone Holding Forceps  
w/ Thread Fixation  
19 cm / 7 1/4"

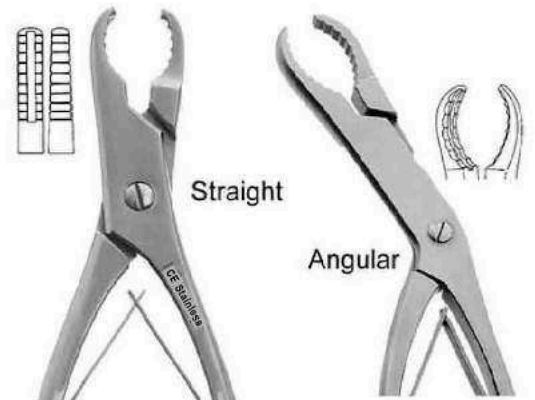

Straight

Angular

30-587-00  
Ulrich  
Bone Holding  
Forceps  
w/ Thread Fixation  
A: 23 cm / 9"  
A: 25 cm / 9 3/4"  
A: 28 cm / 11"



30-586-00  
Self Centering  
Bone Holding  
Forceps  
W/ Thread Fixation

Available in:  
Available in:  
A: 15 cm / 6"  
B: 19 cm / 17 1/2"  
C: 24 cm / 9 1/2"  
D: 26 cm / 10 1/4"  
E: 28 cm / 11"

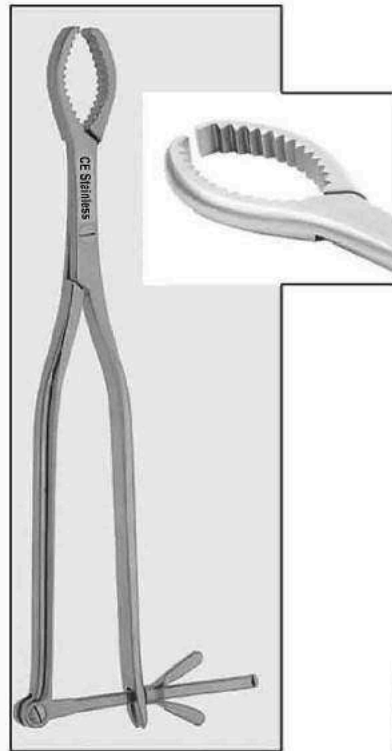

30-588-00  
Hey Groves  
Bone Holding Forceps  
A: 20 cm / 8"  
B: 25 cm / 10"  
C: 30 cm / 12"



30-588-00A  
Lane Bone Holding Forceps  
w/ Ratchet  
A: 33 cm / 13"  
B: 45 cm / 17 3/4"

30-588-00B  
without  
Ratchet

# BONE HOLDING FORCEPS



Enlarged Tip  
of 25cm Shown

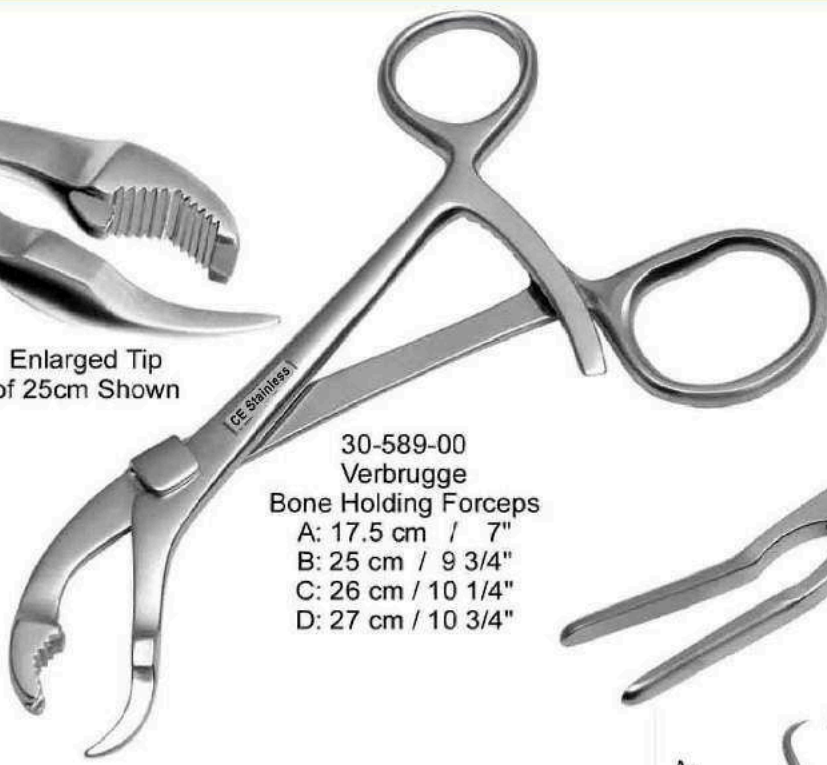

30-589-00  
Verbrugge  
Bone Holding Forceps  
A: 17.5 cm / 7"  
B: 25 cm / 9 3/4"  
C: 26 cm / 10 1/4"  
D: 27 cm / 10 3/4"



30-590-23  
Smooth Jaws  
Bone Holding Forceps  
23 cm / 9"

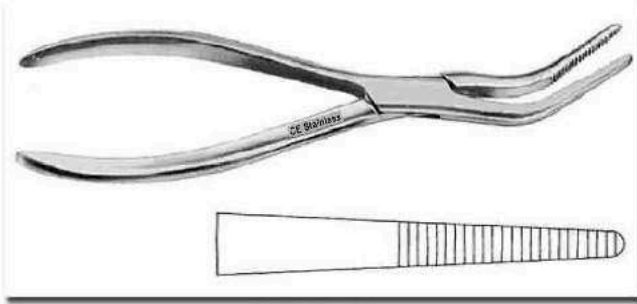

30-591-21  
Van Buren Bone Holding Forceps 21.5 cm / 8 1/2"

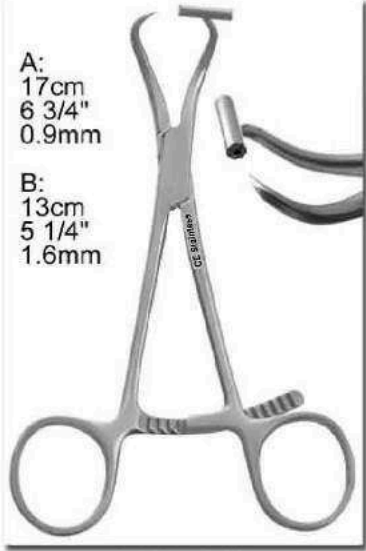

A:  
17cm  
6 3/4"  
0.9mm  
B:  
13cm  
5 1/4"  
1.6mm

30-592-00  
Bone Holding Forceps

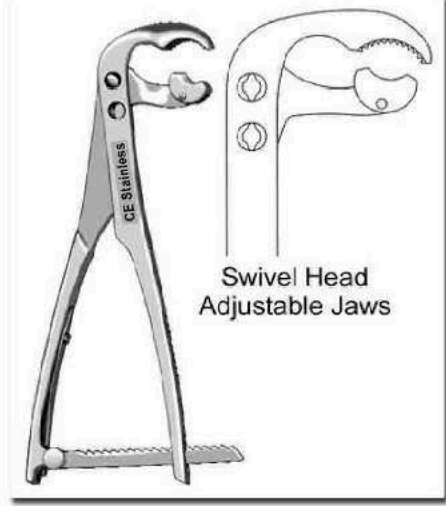

Swivel Head  
Adjustable Jaws

30-593-23  
Angled Bone Holding Forceps  
23 cm / 9"



30-594-23  
Bishop Bone Holding Forceps  
23 cm / 9"

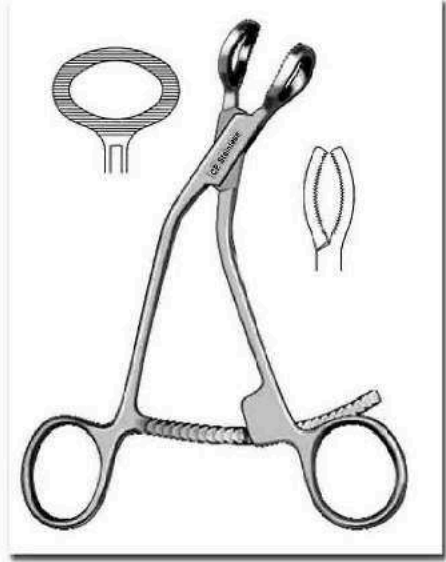

30-595-23  
Bishop Bone Holding Forceps  
23 cm / 9"



1X2 Prong

2X2 Prong

30-596-18  
Patella Forceps  
18 cm / 7"

# CARTILAGE - REPOSITION FORCEPS



30-602-00  
Walton  
Cartilage Seizing Forceps  
20.5 cm / 8"  
A: Straight  
B: Upward Cvd  
C: Sideward Cvd

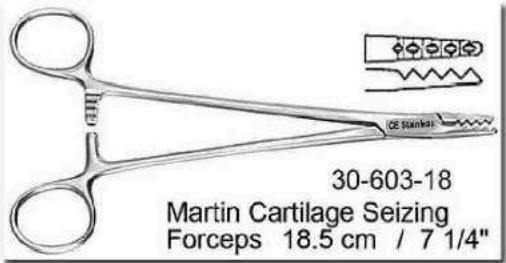

30-603-18  
Martin Cartilage Seizing  
Forceps 18.5 cm / 7 1/4"



30-604-18  
Dingmann Cartilage Seizing  
Forceps 18.5 cm / 7 1/4"

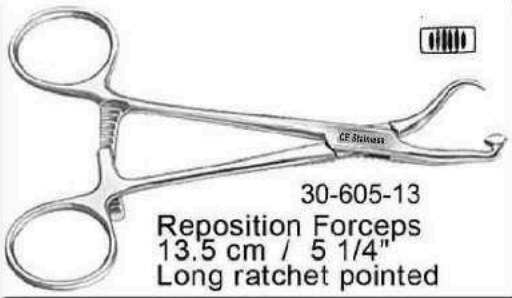

30-605-13  
Reposition Forceps  
13.5 cm / 5 1/4"  
Long ratchet pointed

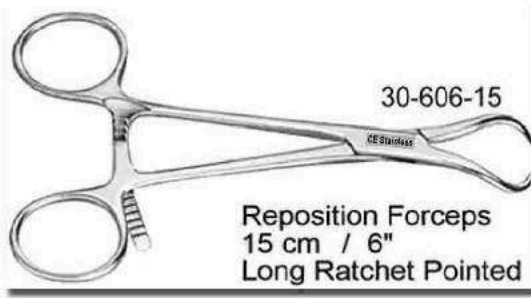

30-606-15  
Reposition Forceps  
15 cm / 6"  
Long Ratchet Pointed

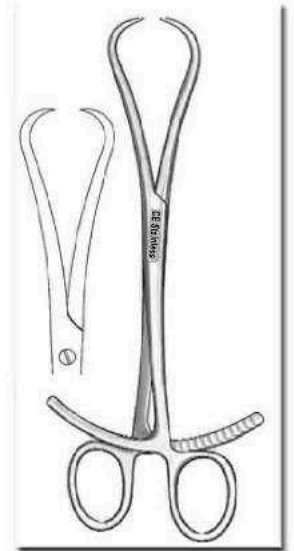

30-607-20  
Walton Bone  
Reduction Forceps  
20.5 cm / 8"  
2" Double Ratchet  
Opening 9-100mm

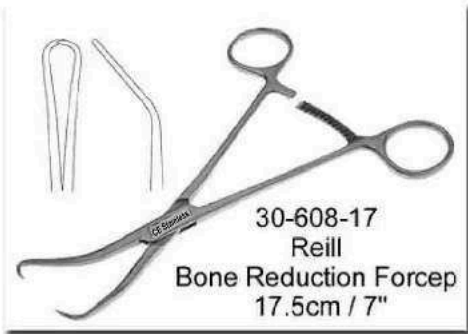

30-608-17  
Reill  
Bone Reduction Forcep  
17.5cm / 7"

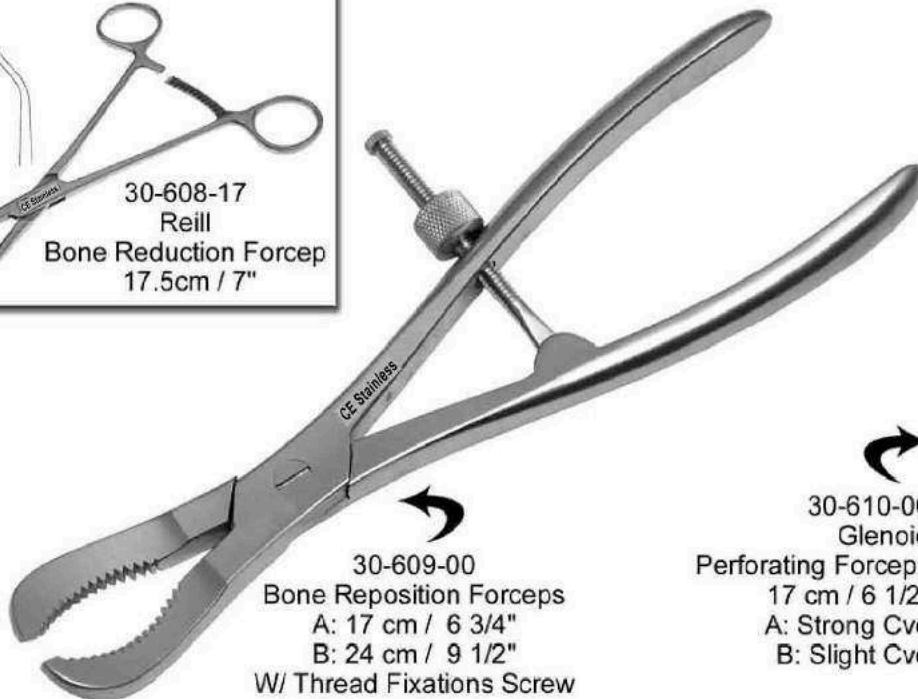

30-609-00  
Bone Reposition Forceps  
A: 17 cm / 6 3/4"  
B: 24 cm / 9 1/2"  
W/ Thread Fixations Screw

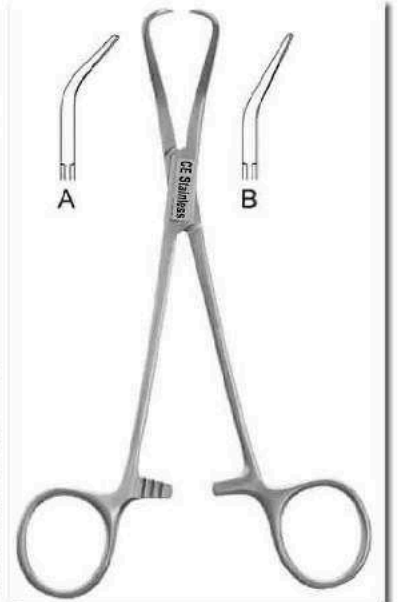

30-610-00  
Glenoid  
Perforating Forceps  
17 cm / 6 1/2"  
A: Strong Cvd  
B: Slight Cvd

# BONE CUTTING FORCEPS

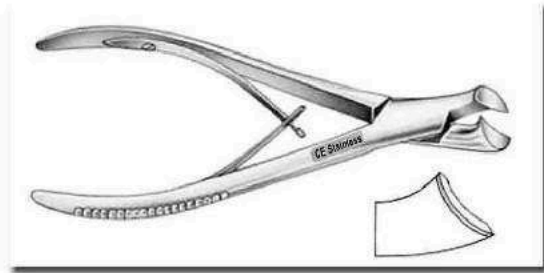

30-611-00  
Marwalder Bone Nipper 18.5 cm / 7 1/4"

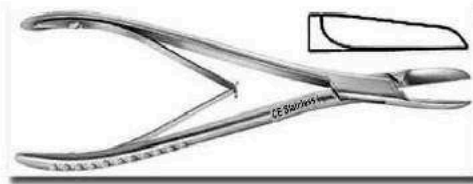

30-612-00  
Cottle Kazanjian Bone Cutting Forceps  
18.5 cm / 7 1/4"

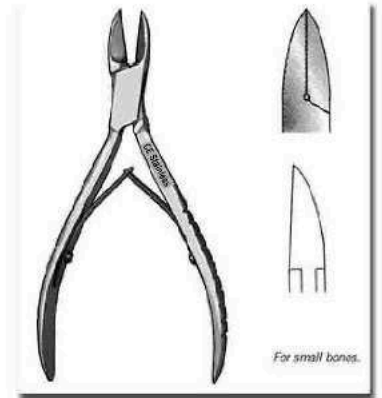

30-613-00  
Littauer Bone Cutting Forceps  
15 cm / 6"  
*For small bones.*



30-614-00  
Liston Bone Cutting Forceps

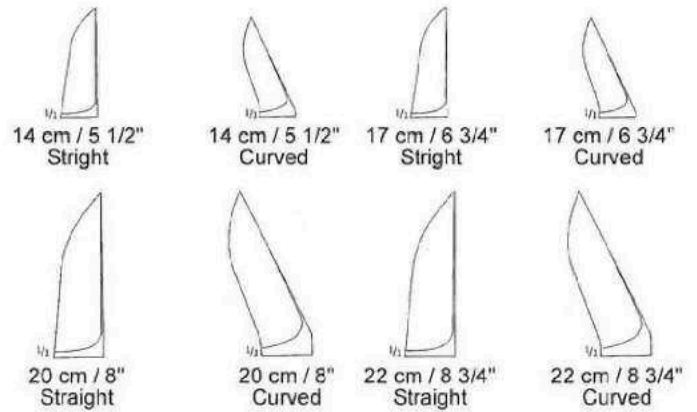

30-615-00  
Cleveland Bone Cutting Forceps  
A: 14.5 cm / 5 3/4"  
B: 17 cm / 6 3/4"

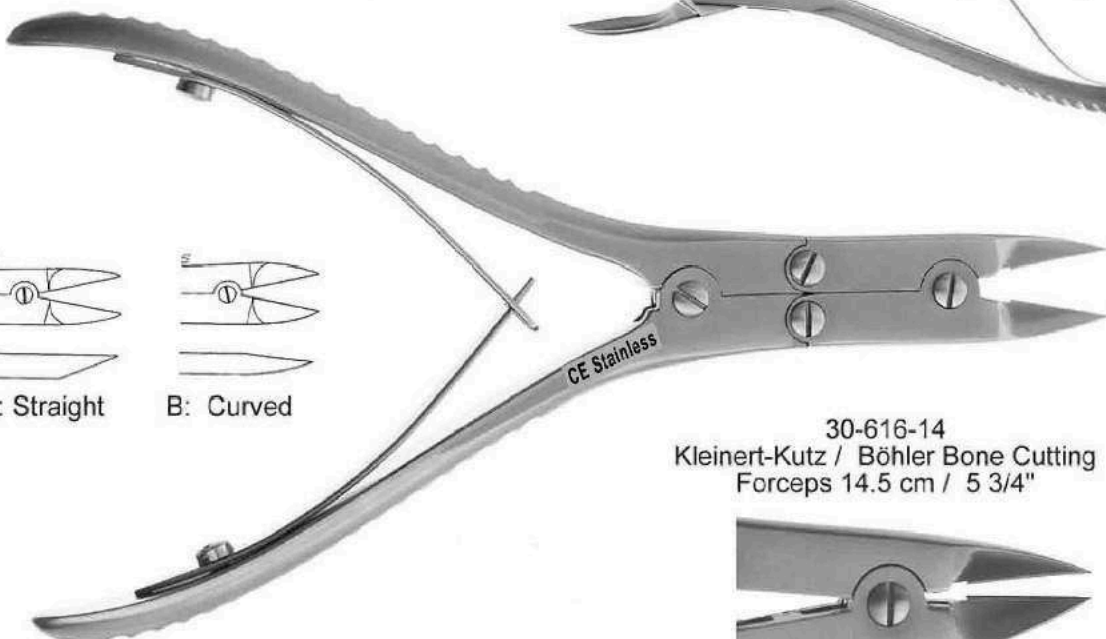
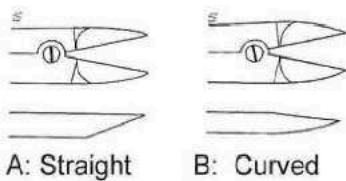
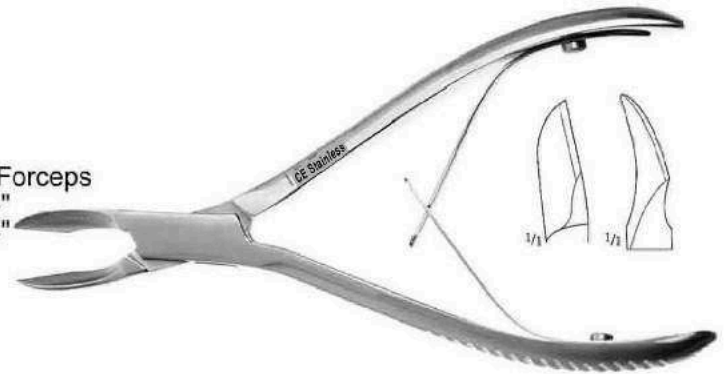

30-616-14  
Kleinert-Kutz / Böhler Bone Cutting  
Forceps 14.5 cm / 5 3/4"



# BONE CUTTING FORCEPS

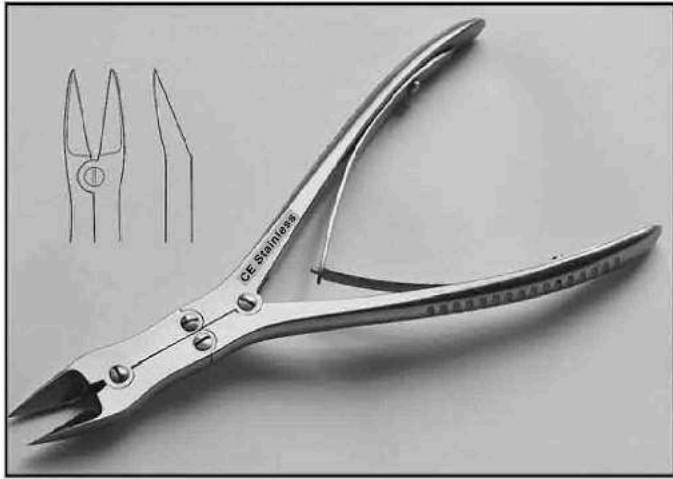

30-621-18  
Mc Indoe  
Bone Cutting Forceps  
18 cm / 7"  
Delicate Blades



30-622-25  
Stille-Horsley / Liston Key  
Bone Cutting Forceps  
25.5 cm / 10"

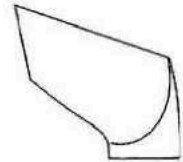

45° Angled

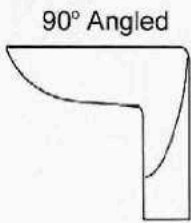

90° Angled

Angled On Side

30-623-24  
Semb  
Bone Cutting Forceps  
24.5 cm / 9 3/4"

# BONE RONGEURS - NIBBLERS

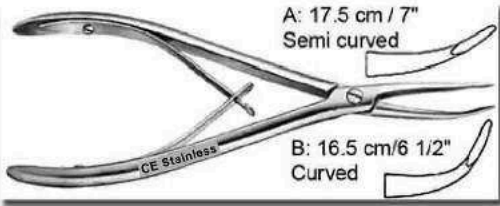

30-624-00 Stellbrink Bone Rongeur

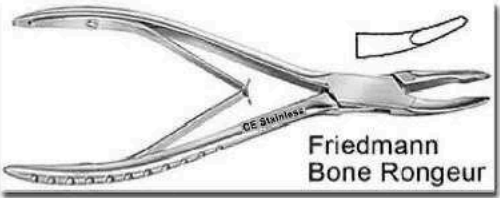

30-625-00 A: 12.5 cm / 5"  
B: 13.5 cm / 5 1/4"



30-626-13 13.5 cm / 5 1/4"

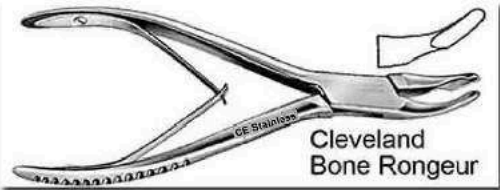

30-627-00 A: 13.5 cm / 5 1/4" B 16.5 cm / 6 1/2"



30-628-16 Mead Bone Rongeur  
16.5 cm / 6 1/2"

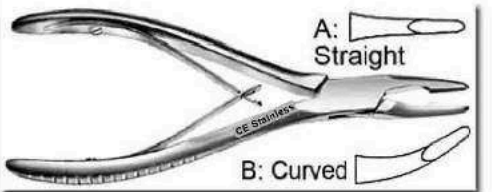

30-629-18 Jansen Bone Rongeur 18 cm / 7"

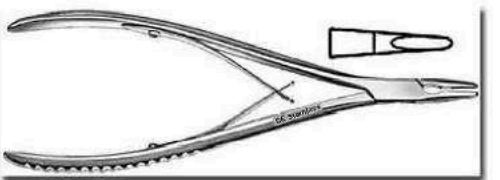

30-630-19 Lempert Bone Rongeur  
19 cm / 7 1/2"



30-632-17 Hartmann Bone Rongeur 17.5 cm / 7"



30-634-00 Jansen Bone Rongeur A: 14 cm / 5 1/2" B: 17 cm / 6 1/2" Straight

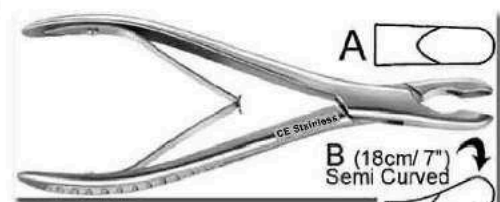

# BONE RONGEURS - NIBBLERS

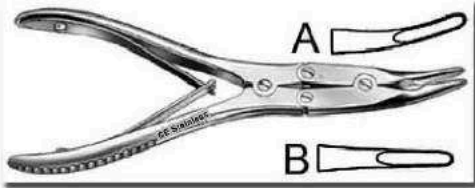

30-638-15 Böhler Bone Rongeur  
15.5 cm / 6"



30-639-18 Beyer Bone Rongeur  
18 cm / 7"



30-640-18 Zaufal-Jansen  
Bone Rongeur 18 cm / 7"



30-641-18  
Mayfield Bone Rongeur  
18 cm / 7"



30-642-20 Marquard  
Bone Rongeur 20.5 cm / 8"



30-643-22  
Stille Bone Rongeur  
22.5 cm / 8 3/4"

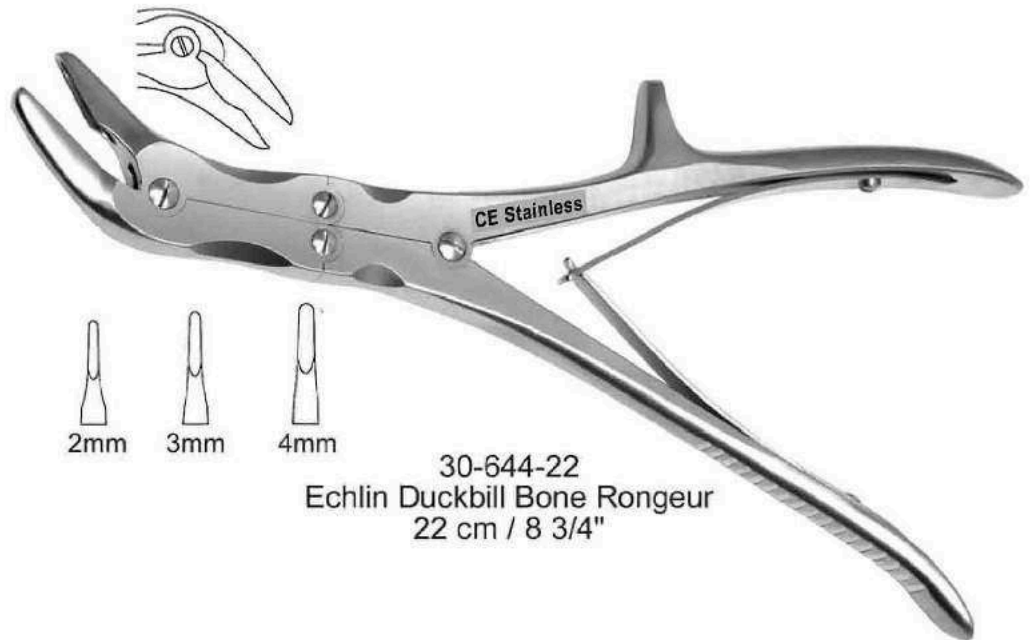

30-644-22  
Echlin Duckbill Bone Rongeur  
22 cm / 8 3/4"



30-645-00  
Ruskin Bone Rongeur

← A: 18 cm / 7"

B: 24 cm / 9 1/2" →

# BONE RONGEURS - NIBBLERS

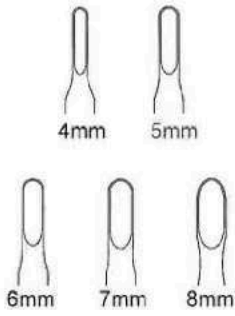

Same Size In  
Both Rongeurs

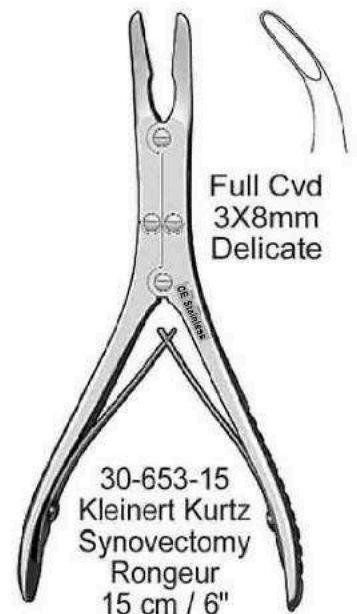
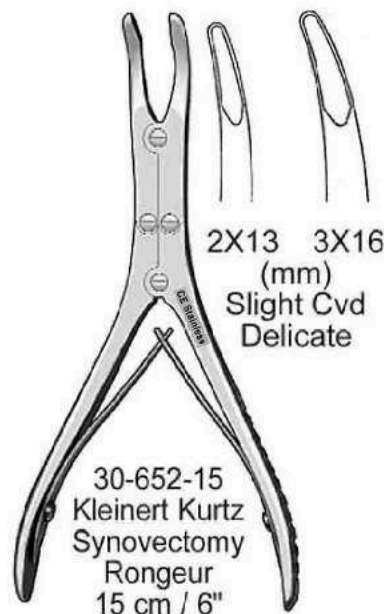
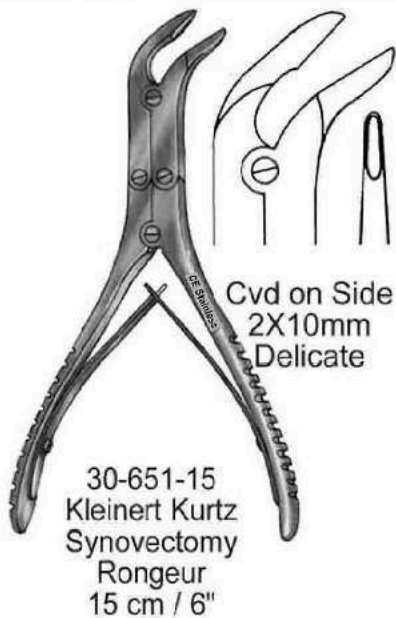
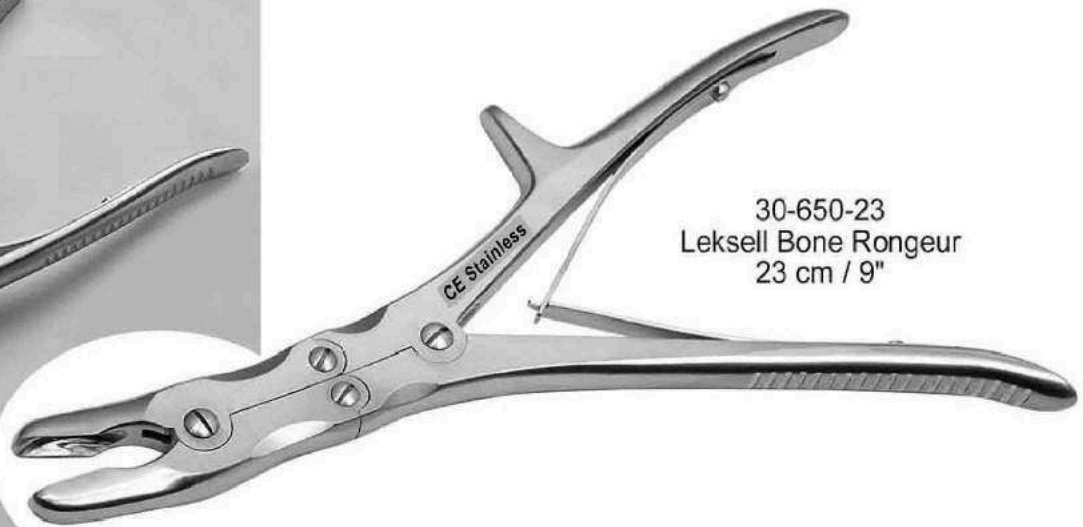
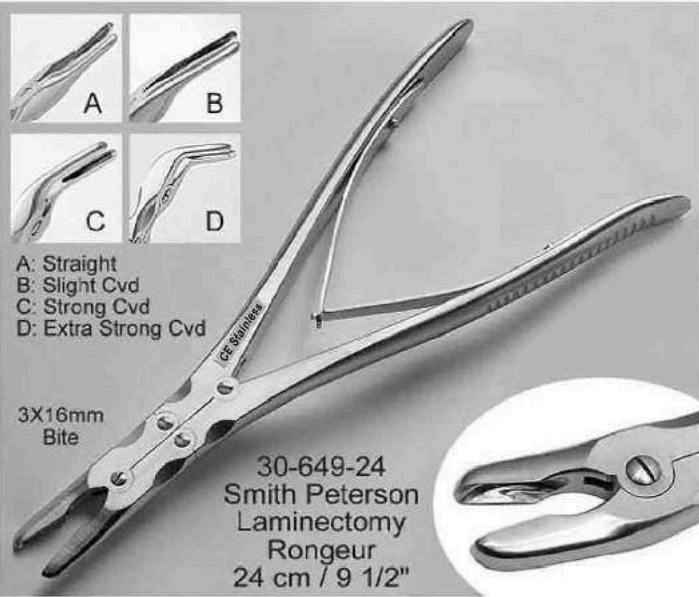
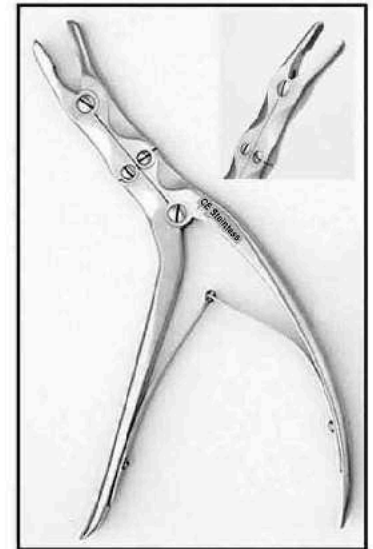
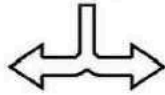



BONE RONGEURS - NIBBLERS

Tooth  
Inside



30-654-23  
Semb Bone Rongeur  
23.5 cm / 9 1/4"

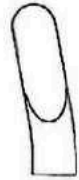
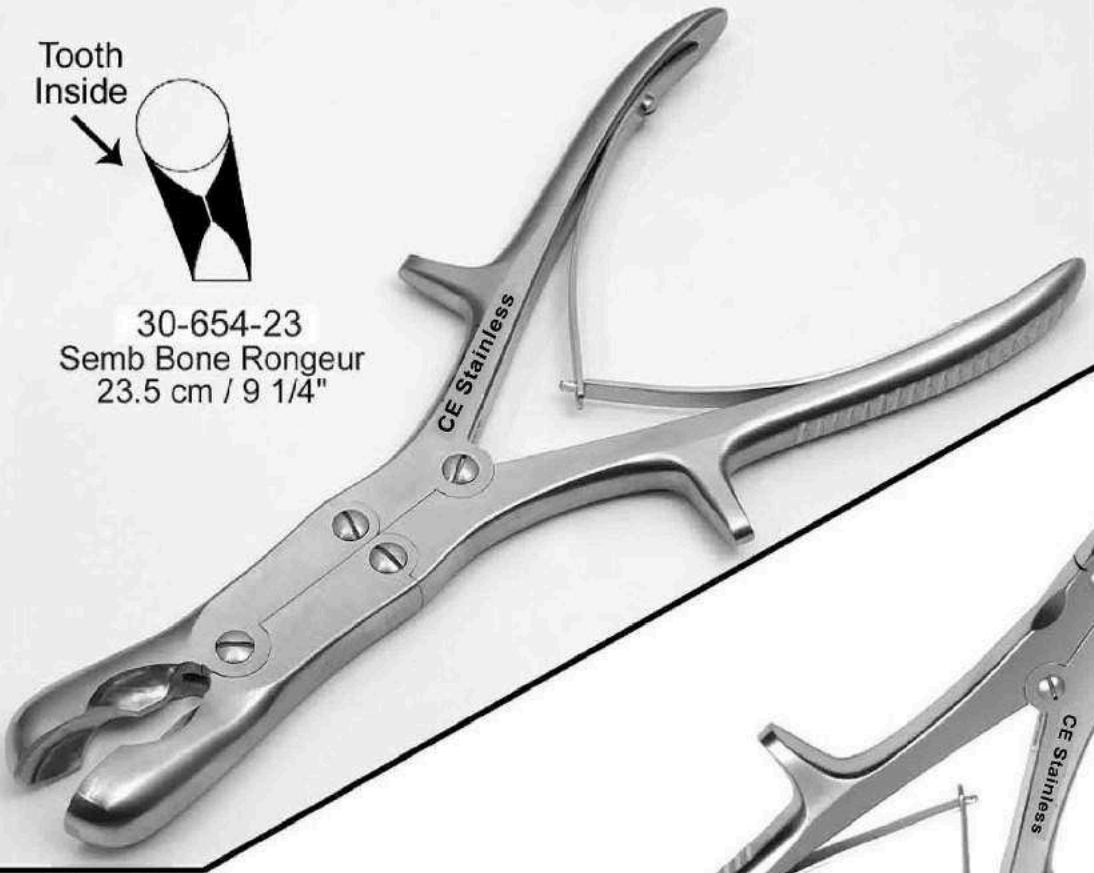

8mm

30-655-23  
Stille Ruskin  
Bone Rongeur  
23.5 cm / 9 1/4"

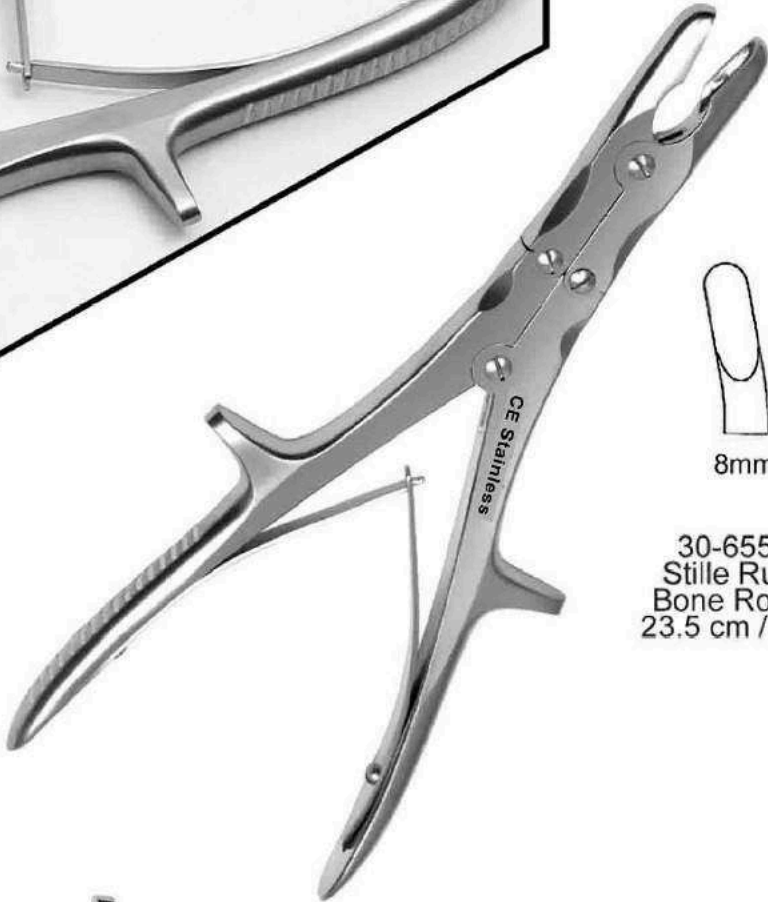

30-656-23  
Stille Luer  
Bone Rongeur  
23 cm / 9"

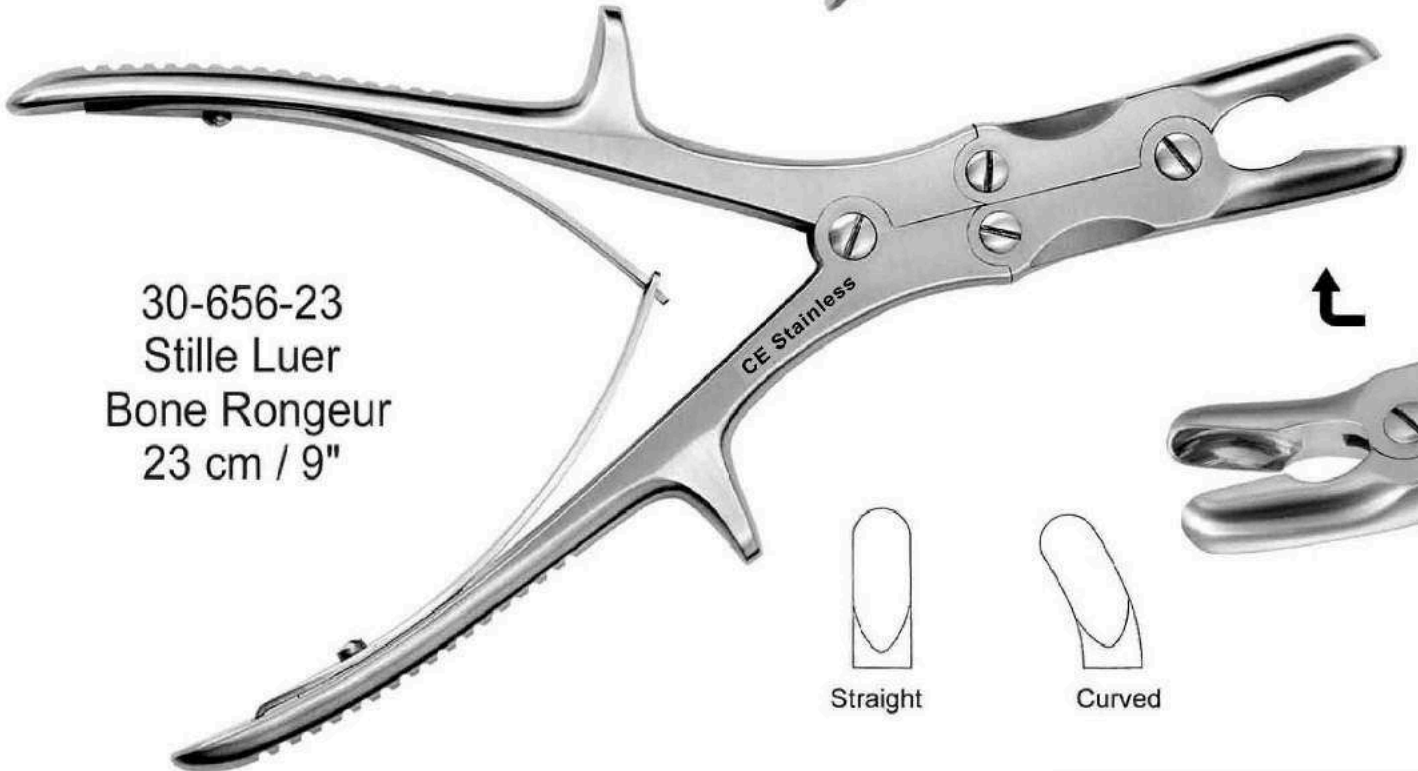

Straight



Curved



# BONE RONGEURS - NIBBLERS

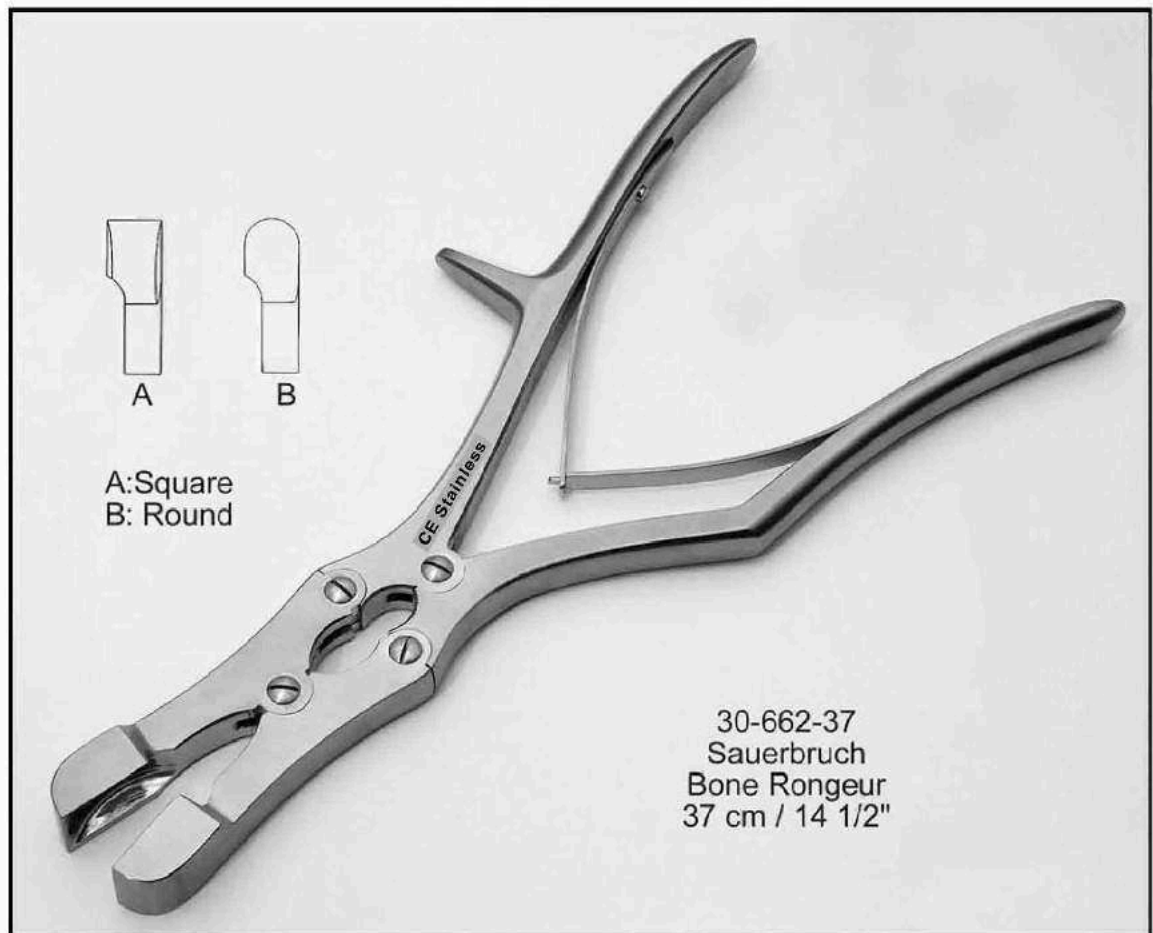
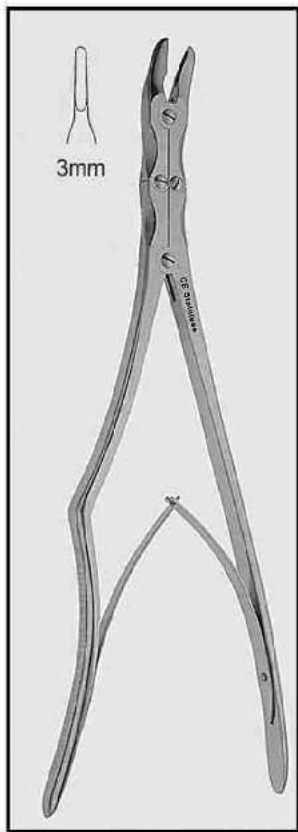
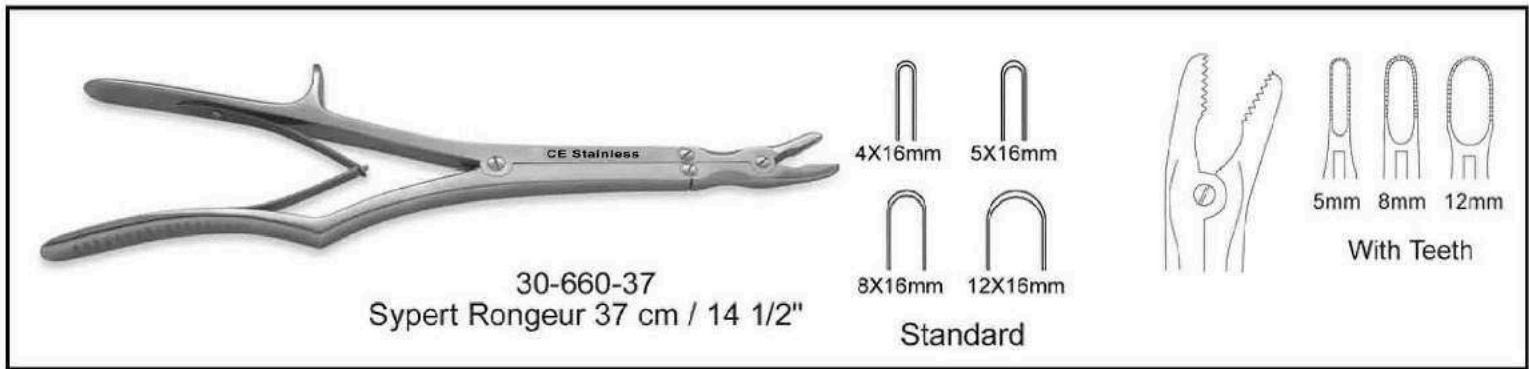
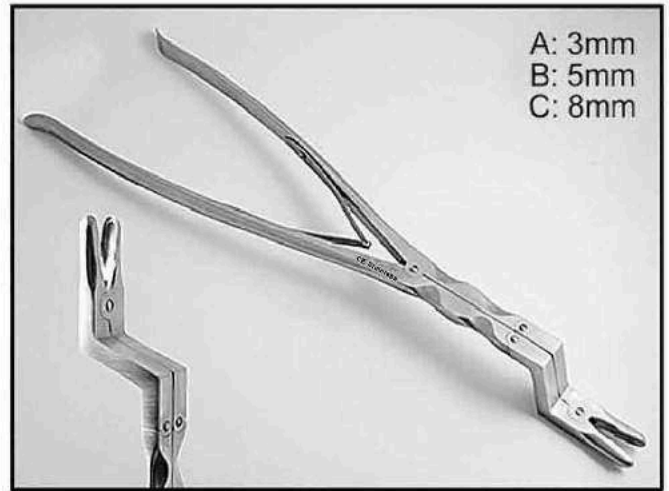
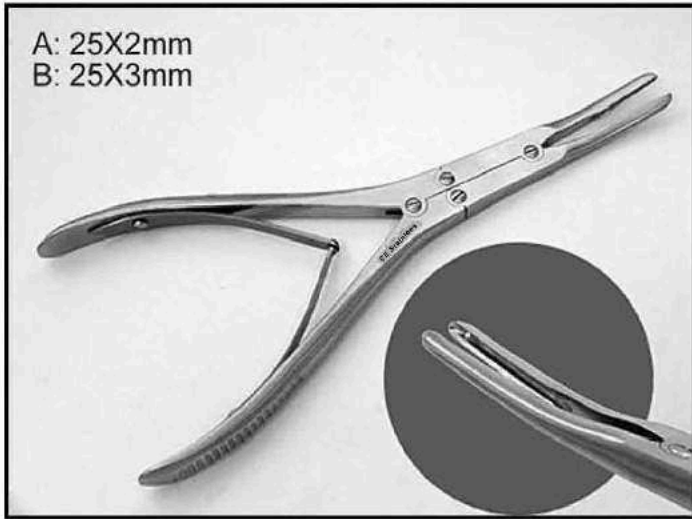

## RIB SHEARS



30-663-22  
Rib Shear  
Double Spring  
22 cm / 8 3/4"

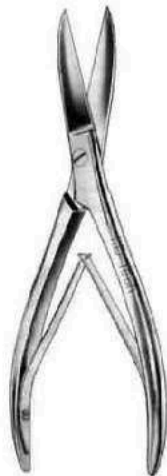

30-664-00  
Rib Shear  
Double Spring  
A: 20 cm / 8"  
B: 23 cm / 9"



30-665-17  
Collin Rib Shear  
17.5 cm / 7"



30-666-17  
Collin Rib Shear  
17 cm / 6 3/4"



30-667-21  
Stille Rib Shear  
21 cm / 8 1/4"



30-668-00  
Gluck  
Rib Shear  
A: 16 cm / 6"  
B: 18 cm / 7"  
C: 20 cm / 8"  
D: 23 cm / 9"

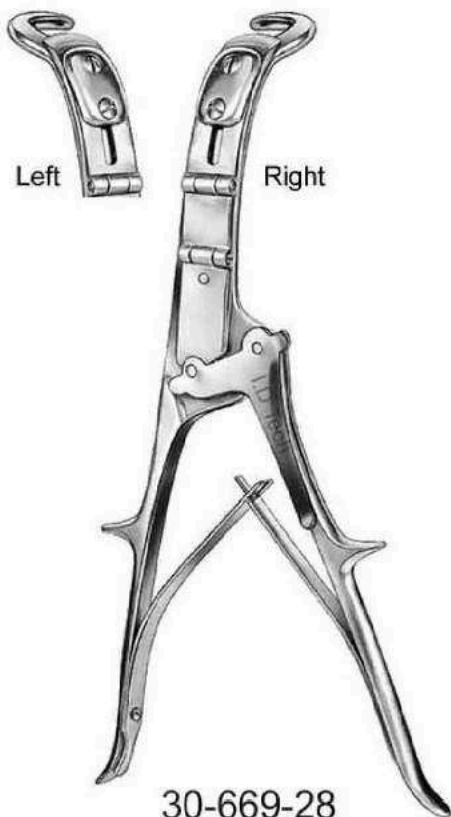

Left Right

30-669-28  
Brunner  
Rib Shear  
28 cm / 11"



30-670-25  
Giertz Stille  
Rib Shear  
25 cm / 10"



30-671-00  
Sauerbruch  
Rib Shear  
A: 23 cm / 9"  
A: 26 cm / 10 1/4"

# RIB SHEARS - STERNUM CHISEL



30-672-25  
Labsche  
Rib Shear  
25 cm / 10"



30-673-24  
T Handle Labsche Sternum Chisel  
24 cm / 9 1/2"



30-674-17  
Rib Shear  
Sideward  
17 cm / 6 3/4"



Pointed  
Tips

12-208-34A  
Bethune Rib Shear  
S Shaped Handle  
34 cm / 13 1/2"

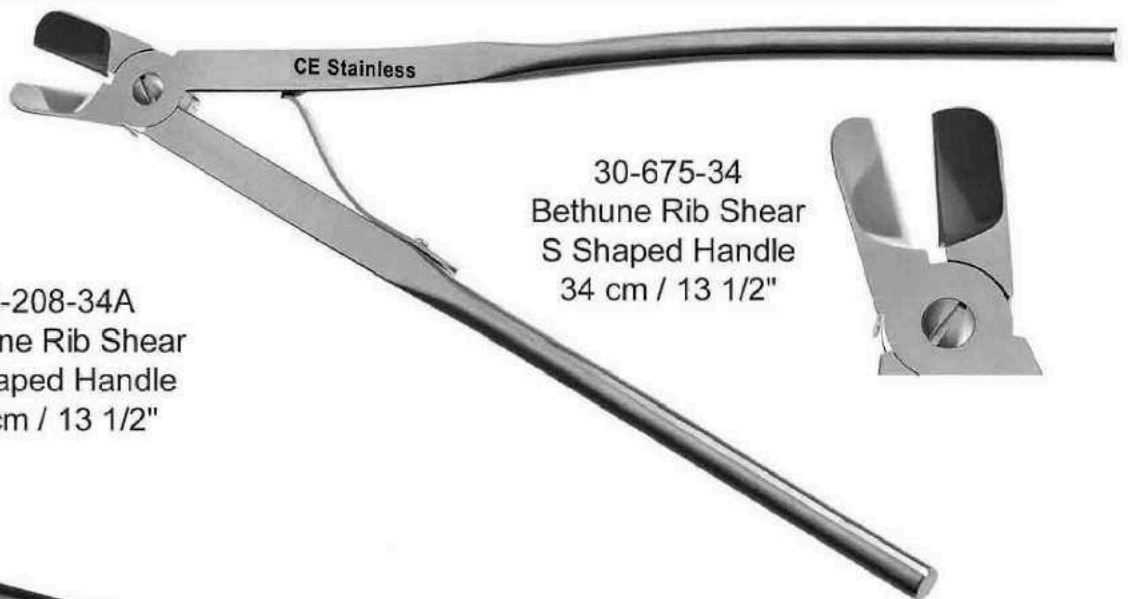

30-675-34  
Bethune Rib Shear  
S Shaped Handle  
34 cm / 13 1/2"

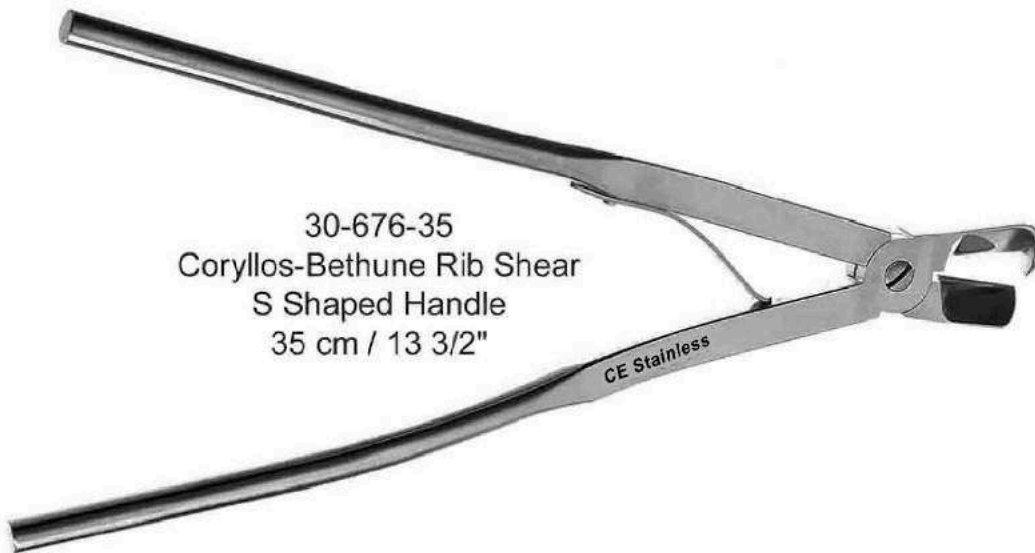

30-676-35  
Coryllos-Bethune Rib Shear  
S Shaped Handle  
35 cm / 13 3/2"



Left

Right



30-677-33  
Roos Rib Shear  
Right Angled Jaw W/ Hook  
33 cm / 13"

# SPREADERS

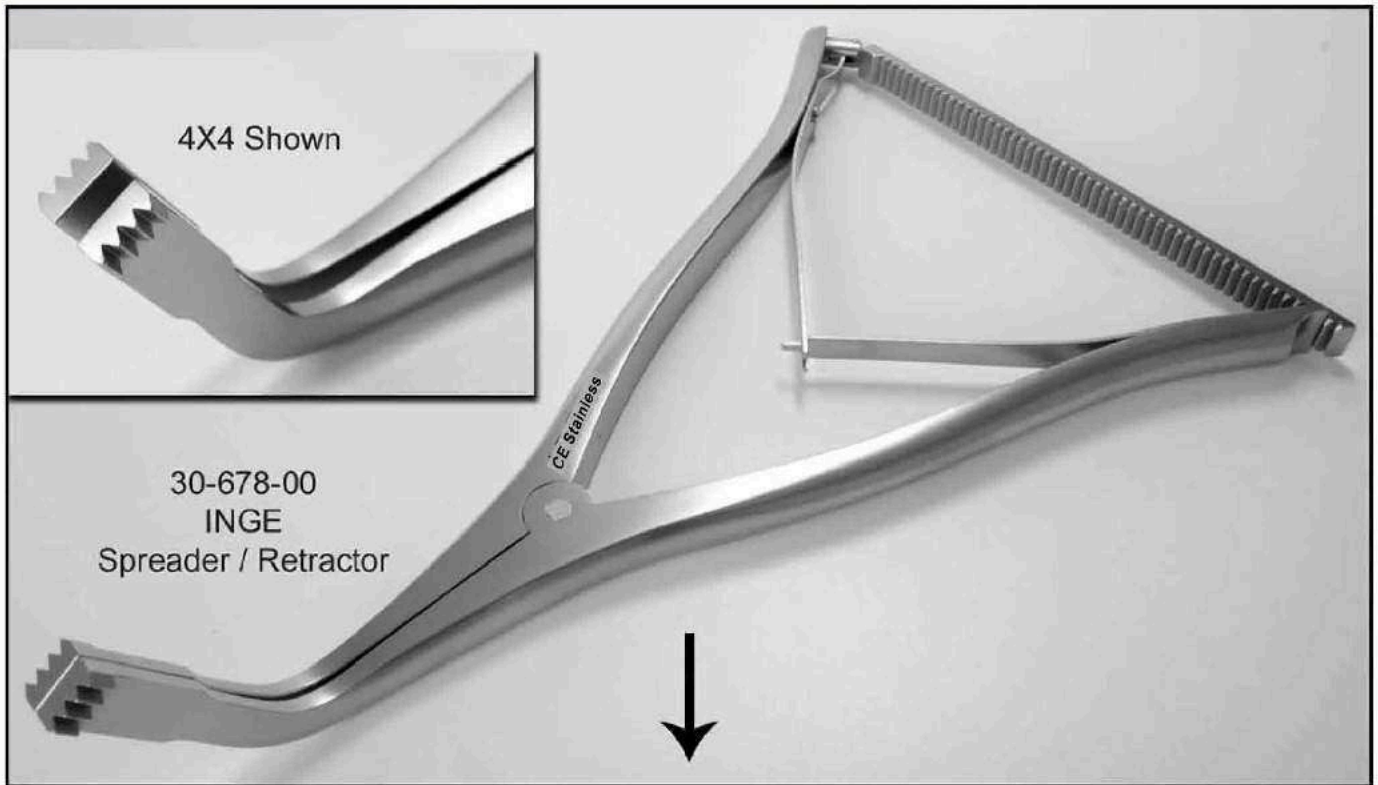

Available in 4X4 and 6X6 Teeth and Without Teeth (Plain)

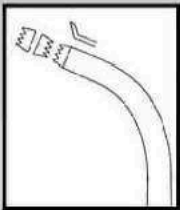

A: 4X4 Teeth  
B: Without Teeth  
16.5 cm / 6 1/2"

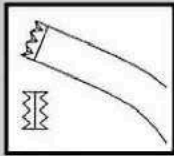

C: 4X4 Teeth  
D: Without Teeth  
25.5 cm / 10"

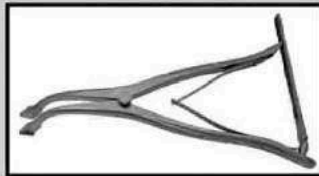

10 Inch Length Pattern

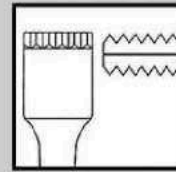

A: 6X6 Teeth  
B: Without Teeth  
27 cm / 10 1/2"  
Flat Blades

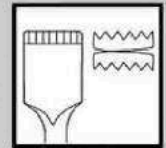

C: 6X6 Teeth  
C: Without Teeth  
27 cm / 10 1/2"  
Concave Blades



30-679-25  
Offset Lamina  
Spreader / Retractor  
25.5 cm / 10"

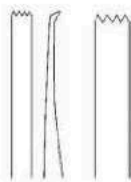

30-680-00  
Vertebra  
Spreader  
/ Retractor  
A: 18 cm / 7"  
B: 28 cm / 11"



30-681-00  
Inge Spreader  
Serrated Outside  
Blades  
A: 18 cm / 7"



30-682-00  
Saxsena Lamina  
Spreader / Retractor  
A: 18 cm / 7"  
B: 25.5 cm / 10"  
Serrated Outside  
Blades



# SPREADERS

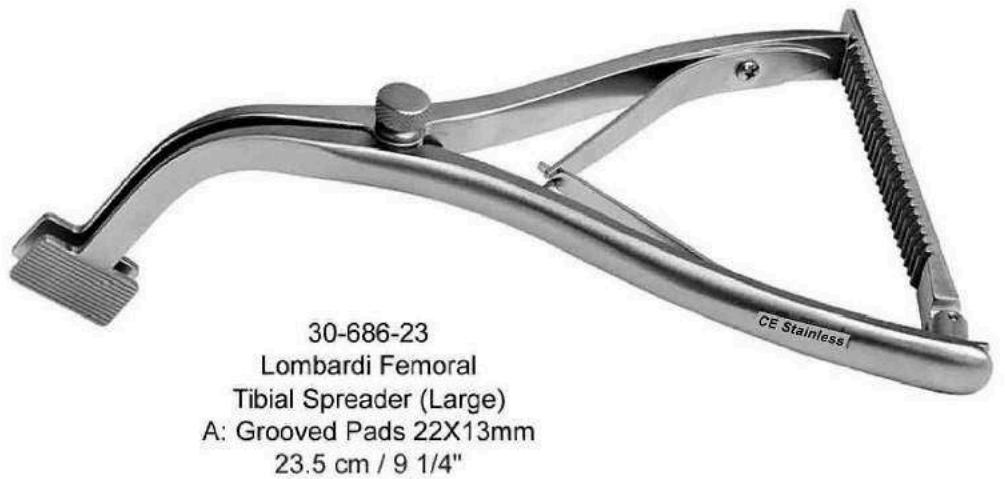

## COMPRESSION - DISTRATING FORCEPS



30-687-28  
Compressing Forceps  
28 cm / 11"  
Adjustable Locking  
For Screws and Rods



30-688-23  
Distracting Forceps  
23 cm / 9"  
Long Ratchet / Spiral Pring  
For Screws and Rods



30-689-25  
Distracting Forceps  
25.5 cm / 10"  
Leaf Pring  
For Screws and Rods



30-690-28  
Compression Forceps  
28 cm / 11"  
Leaf Pring / Long Ratchet  
For Screws and Rods



30-691-25  
Distractor  
25.5 cm / 10"  
Leaf Pring  
For Screws and Rods

# PLATE BENDERS

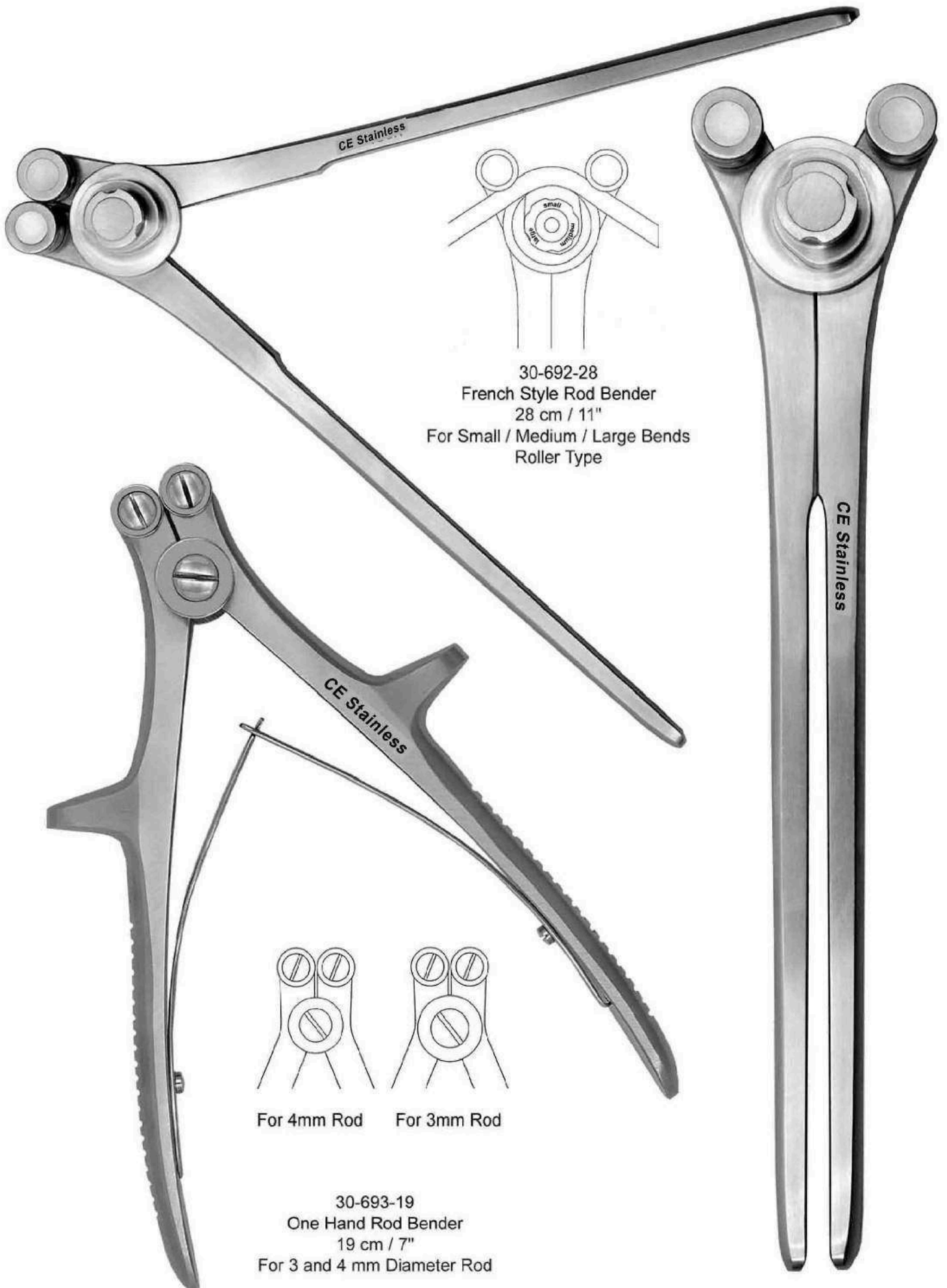

30-692-28  
French Style Rod Bender  
28 cm / 11"  
For Small / Medium / Large Bends  
Roller Type

For 4mm Rod    For 3mm Rod

30-693-19  
One Hand Rod Bender  
19 cm / 7"  
For 3 and 4 mm Diameter Rod



# CARBIDE INSERTED WIRE TWISTERS

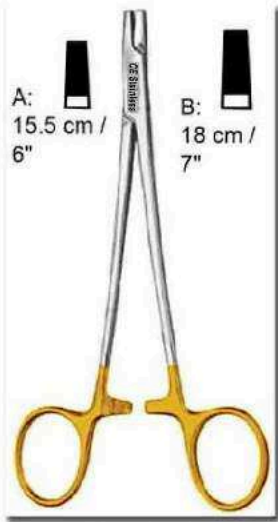

A: 15.5 cm / 6"  
B: 18 cm / 7"

694-15-TC A / B  
Wire Twisting  
Forceps

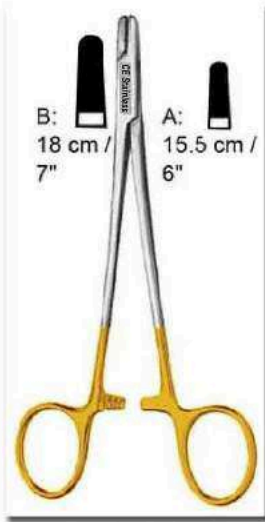

B: 18 cm / 7"  
A: 15.5 cm / 6"

695-15-TC A / B  
Wire Twisting  
Forceps

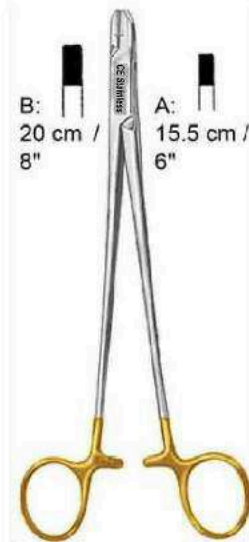

B: 20 cm / 8"  
A: 15.5 cm / 6"

696-15-TC A / B  
Wire Twisting  
Forceps



697-18-TC Corwin  
Combi-Wire Twisting  
Forceps  
18.5 cm / 7 1/4"



698-15-TC  
Wire Twisting Forceps  
15.5 cm / 6"

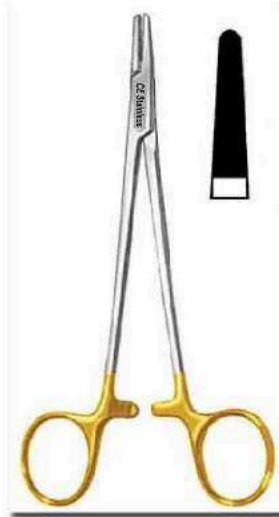

699-16-TC  
Wire Twisting Forceps  
16 cm / 6 1/4"



700-19-TC Wire Twisting  
Forceps Heavy Pattern  
19 cm / 7 1/2"

The Corwin-Hegar automatic Wire Twister is a special automatic twisting Instrument. In combination with a cerclage wire it can be used for fixation of fractures or temporal fixation. The Automatic Wire Twisters are available in different lengths and with various tungsten carbide inserts.



701-15-TC Corwin-Hegar  
Auto Wire Twisting Forceps  
15 cm / 6"



702-28-TC  
Jet Wire Twisting Device  
28 cm / 11" - 10mm Tip

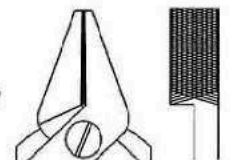

# CARBIDE INSTERTED SURGICAL SCISSORS

Scissors in this Section can also be Manufactured without Carbide Tips / Gold Plating

703-00-TC

Mayo

Scissors TC Gold

- A: 14.5 cm / 5 3/4" Str or Cvd  
 B: 17 cm / 6 3/4" Str or Cvd  
 C: 23 cm / 9" Str or Cvd

Blunt / Blunt



Please Mention Above Styles When Ordering Standard TC Scissors

704-00-TC

Operating (Standard)

Scissors TC Gold

- A: 13 cm / 5" Str or Cvd  
 B: 14 cm / 5 1/2" Str or Cvd  
 C: 15.5 cm / 6 1/2" Str or Cvd  
 D: 18 cm / 7" Str or Cvd

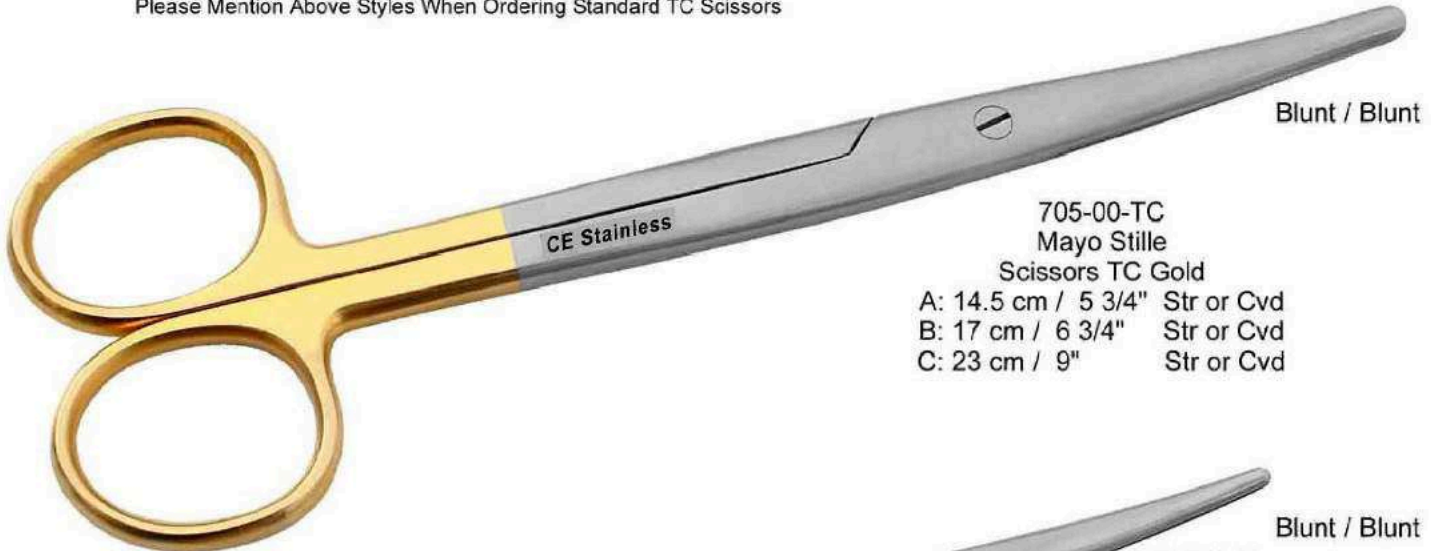

Blunt / Blunt

705-00-TC

Mayo Stille

Scissors TC Gold

- A: 14.5 cm / 5 3/4" Str or Cvd  
 B: 17 cm / 6 3/4" Str or Cvd  
 C: 23 cm / 9" Str or Cvd



Blunt / Blunt

706-00-TC

Metzenbaum

Scissors TC Gold

- A: 14 cm / 5 1/2" Str or Cvd  
 B: 17 cm / 6 3/4" Str or Cvd  
 C: 20 cm / 8" Str or Cvd  
 D: 23 cm / 9" Str or Cvd

Blunt / Blunt

707-00-TC

Mayo-Harrington

Scissors TC Gold

- A: 20 cm / 8" Str or Cvd  
 B: 23 cm / 9" Str or Cvd  
 C: 28 cm / 11" Str or Cvd  
 D: 30 cm / 12" Str or Cvd



708-12-TC  
 Ortho Universal Scissors TC Gold  
 12 cm / 4 1/3"



709-16-TC  
 Mayo-Nobel  
 Scissors TC Gold  
 A: 16.5 cm / 6 1/2"  
 Str or Cvd

# CARBIDE INSERTED WIRE & PIN CUTTERS

710-00-TC

Wire Cutting Plier TC Gold

A: 15 cm / 6" Cut Upto 1.3mm

B: 18 cm / 7" Cut Upto 1.6mm

C: 23 cm / 9" Cut Upto 2.5mm

Angled

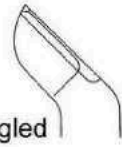

711-00-TC

Wire Cutting Plier TC Gold

A: 15 cm / 6" Cut Upto 1.3mm

B: 18 cm / 7" Cut Upto 1.6mm



712-23-TC

Wire Cutting Plier TC Gold  
23 cm / 9" Cut Upto 2.5mm



713-18-TC

Wire Cutting Plier TC Gold

18 cm / 7" Cut Upto 1.6mm

# CARBIDE INSERTED WIRE & PIN CUTTERS

714-18-TC  
Cannulated Pin Cutter TC Gold  
18 cm / 7" Cut Upto 1.5mm



715-15-TC  
Front End  
Wire Cutting Plier  
TC Gold  
15 cm / 6"  
Cut Upto 1.3mm



716-23-TC  
Front End  
Wire Cutting Plier  
TC Gold  
23 cm / 9"  
Cut Upto 2.5mm



717-23-TC  
Front End  
Wire Cutting Plier  
TC Gold  
23 cm / 9"  
Cut Upto 2.5mm

## CARBIDE INSERTED PIN & PLATE CUTTERS

718-23-TC  
Plate / Pin Cutting Plier  
TC Gold  
23 cm / 9"  
Cut Upto 3.0mm



719-23-TC  
Pin / Wire Cutting Plier  
TC Gold / Adjustable  
23 cm / 9"  
Cut Upto 2.5mm

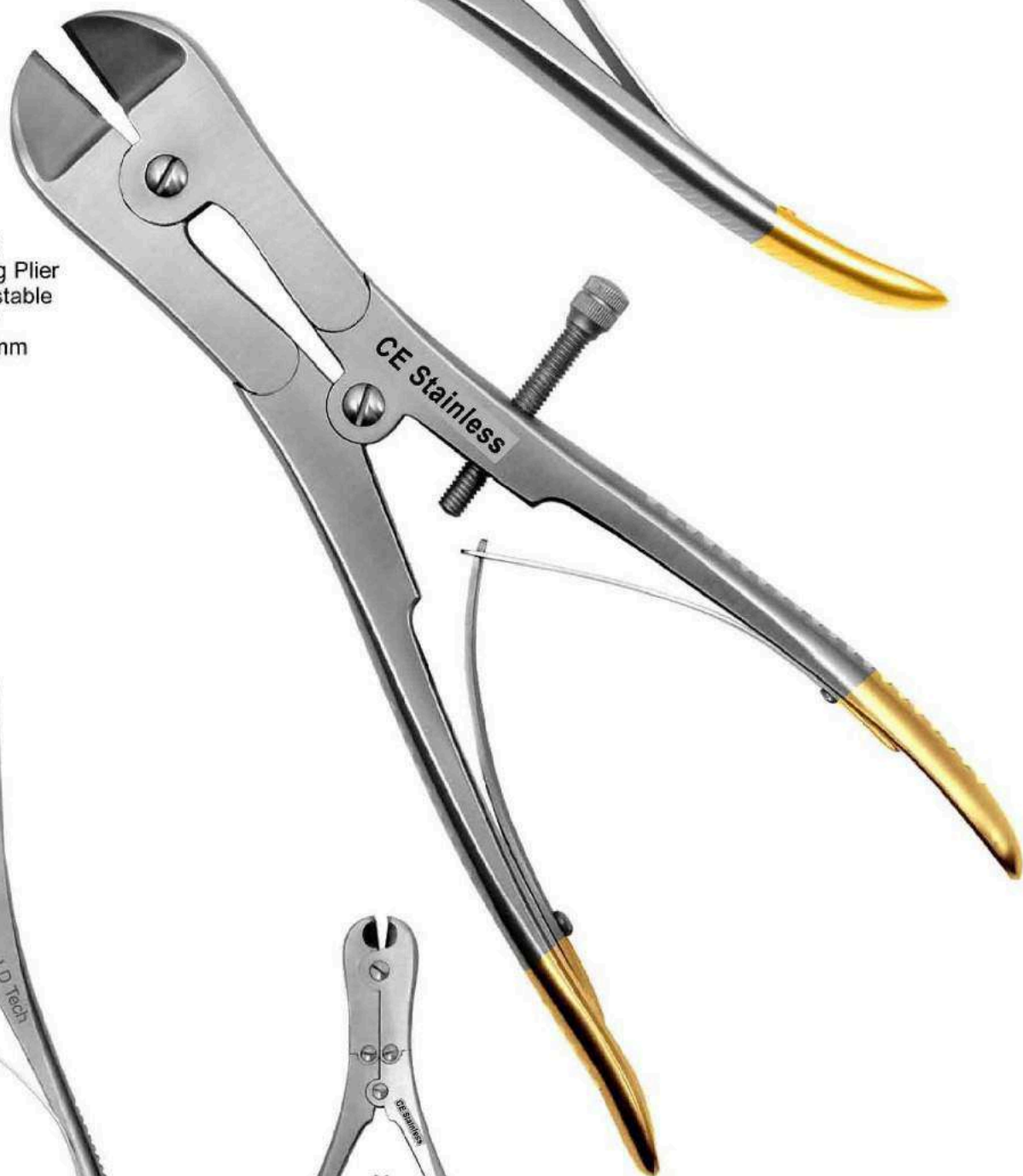

720-23-TC  
Pin / Wire Cutting Plier  
TC Gold  
23 cm / 9"  
Cut Upto 2.5mm

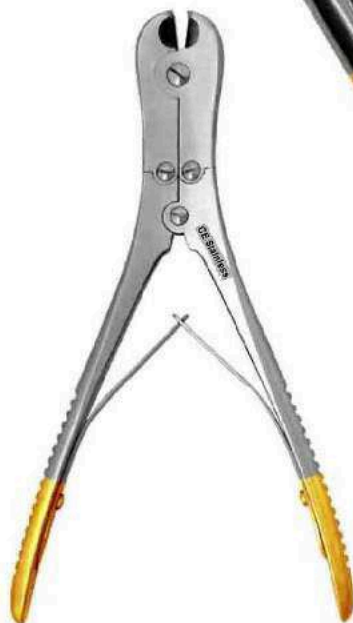

721-18-TC  
Front / Side  
Wire Cutting Plier  
TC Gold  
18 cm / 7"  
Cut Upto 1.6mm

**CARBIDE INSTERTED PIN CUTTERS HEAVYDUTY**



**722-00-TC**  
 Heavy Duty  
 Pin Cutting Plier  
 TC Gold  
 A: 30 cm / 12" Cut Upto 3mm  
 B: 47 cm / 18 1/2" Cut Upto 5mm  
 C: 56 cm / 22" Cut Upto 6mm  
 D: 60 cm / 24" Cut Upto 7mm



**723-00-TC**  
 Heavy Duty  
 Pin End Cutting Plier  
 TC Gold  
 A: 27 cm / 10 1/2" Cut Upto 3mm  
 B: 38 cm / 15" Cut Upto 4mm



**724-00-TC**  
 Heavy Duty  
 Rods / Steinmann Pin Cutting Plier  
 TC Gold / Adjustable / Locking System  
 A: 30 cm / 12" Cut Upto 3mm  
 B: 38 cm / 15" Cut Upto 4mm  
 C: 47 cm / 18 1/2" Cut Upto 5mm  
 D: 56 cm / 22" Cut Upto 6mm

# INSTRUMENTS FOR TRUAMATOLOGY

## Drill Bits for Quick Coupling

Drill bit 1.1mm dia.  
for threaded hole for 1.5mm screws

Drill bit 1.5mm dia.  
For threaded hole for 2.0mm screws and gliding hole for 1.5mm screws

Drill bit 2.0mm dia.  
For threaded hole for 2.7 mm dia.  
For gliding hole for 2.7mm screws

Item	Diameter	Total length	Usable length
310.110 <sup>1</sup>	1.1mm	060mm	035mm
310.150 <sup>1</sup>	1.5mm	085mm	060mm
310.160	1.5mm	110mm	085mm
310.190 <sup>1</sup>	2.0mm	100mm	145mm
310.120	2.0mm	125mm	100mm
310.210 <sup>1</sup>	2.7mm	100mm	075mm
310.280	2.7mm	125mm	100mm
310.260 <sup>1</sup>	2.7mm	100mm	075mm
310.280 <sup>1</sup>	2.0mm	125mm	100mm

Drill bit 2.5mm dia.  
For threaded hole for 3.5 and 4.0mm screws

Item	Diameter	Total length	Usable length
310.250 <sup>1</sup>	2.5mm	110mm	085mm
310.230	2.5mm	180mm	155mm
310.350 <sup>1</sup>	3.5mm	100mm	085mm
310.370	3.5mm	195mm	170mm

Drill bit 3.2mm dia.  
For threaded hole for 4.5 and 6.5mm screws

Item	Diameter	Total length	Usable length
310.190 <sup>1</sup>	2.0mm	100mm	145mm
310.020	3.2mm	225mm	200mm
310.310 <sup>1</sup>	3.2mm	145mm	120mm
310.290	3.2mm	195mm	170mm
310.440 <sup>1</sup>	4.5mm	145mm	120mm
310.480	4.5mm	195mm	170mm

## Drill Bits for Jacobs Type Chuck

Drill Bit for Jacobs chuck

Item	Diameter	Total length	Usable length
310.100	1.1mm	45mm	30mm
310.140	1.5mm	70mm	55mm
310.200	2.0mm	85mm	70mm
310.240	2.5mm	095mm	080mm
310.270	2.7mm	85mm	70mm
310.320	3.2mm	130mm	115mm
310.300	3.2mm	180mm	165mm
310.360	3.5mm	095mm	080mm
310.380	3.5mm	180mm	165mm
310.450	4.5mm	130mm	115mm
310.490	4.5mm	180mm	165mm



Tap for 2.0mm Cortex Screws  
Predrilling: 1.5mm dia.

Item	Thread length	Total length
311.190 <sup>1</sup>	24mm	053mm
311.210	38mm	100mm

Tap for 2.7mm Cortex Screws  
Predrilling: 2.0mm dia.

Item	Thread length	Total length
311.260 <sup>1</sup>	33mm	100mm
311.280	40mm	150mm

311.280<sup>1</sup>  
Tap for 2.7mm Cortex Screws  
total length 125mm, thread length 40mm  
predrilling: 2.0mm dia.

Predrilling: 3.2mm

Item	Length	Type
311.460 <sup>1</sup>	125mm	thread length 70mm
311.470	175mm	with length markings

Tap for 3.5mm Cortex Screws  
Predrilling: 2.5mm dia.

Item	Total length	Type
311.310	175mm	with length markings
311.320 <sup>1</sup>	110mm	thread length 50mm

311.320

Tap for 3.5mm Cortex Screws  
total length 110mm, thread length 50mm  
predrilling: 2.5mm dia.

311.460<sup>1</sup>

Tap for 4.5mm Cortex Screws  
total length 125mm, thread length 70mm  
predrilling: 3.2mm dia.

310.880<sup>1</sup>  
Countersink Shaft 1.5/2.0  
length 52mm, for mini quick coupling

332.050  
Router, for Jacobs chuck  
length 90mm

332.060<sup>1</sup>  
Router, for quick coupling  
length 90mm

310.990<sup>1</sup>  
Countersink, large  
length 180mm, for 4.5mm cortex screws

310.890<sup>1</sup>  
Countersink Shaft 3.5mm  
length 72mm, for quick coupling,  
to countersink the screw head

310.790  
Countersink, cannulated, for 7.0mm Cannulated Screws  
length 230mm

310.950<sup>1</sup>  
Handle with mini quick coupling

392.040  
Hand Chuck for Kirschner Wires  
length 145mm, Spannbereich 0.6 to 1.6mm dia.

311.430<sup>1</sup>  
Handle with quick coupling  
length 110mm  
for countersinks and  
instruments for the removal of damaged screws

311.440<sup>1</sup>  
T-Handle with quick coupling  
length 80mm, for taps

311.011  
Handle, small, with mini quick coupling

311.012  
Handle, medium, with mini quick coupling

311.013  
Handle, large, with mini quick coupling

314.140  
Allen Key, hexagonal, angled  
for 4.5 to 7.0mm screws

314.160  
Allen Key, hexagonal, small, angled  
length 65mm, for 2.7 to 4.0mm screws

314.030<sup>1</sup>  
Screwdriver Shaft, hexagonal, small  
length 100mm, for quick coupling  
For 2.7 to 4.0mm screws.

314.320<sup>1</sup>  
Screwdriver Shaft, hexagonal, with Holding Sleeve  
for 1.5 and 2.0mm stainless steel screws  
with hexagonal socket,

314.130  
Screwdriver, hexagonal, with T-Handle,  
large to loosen tight screws.  
A normal screwdriver can be  
additionally inserted in the hollow  
shaft of the T-handle.

314.170  
Screwdriver with Universal Joint, large  
length 290mm.

314.300  
Screwdriver, hexagonal, with Holding Sleeve,  
length 165mm for 1.5 and 2.0mm stainless  
steel screws with hexagonal socket

314.060  
Holding Sleeve

314.150<sup>1</sup>  
Screwdriver Shaft, Hexagonal, large  
length 100mm,  
Final tightening of the screw has to  
be done by hand.

314.670<sup>1</sup>  
Screwdriver Shaft, cruciform, 1.5/2.0, with Holding Sleeve  
length 50mm, for 1.5 and 2.0mm

314.070<sup>1</sup>  
Screwdriver, hexagonal, small with groove  
length 200mm, for 2.7 to 4.0mm screws

314.270<sup>1</sup>  
Screwdriver, hexagonal, large, with groove  
length 240mm

314.020<sup>1</sup>  
Screwdriver, hexagonal, small, with Holding Sleeve  
length 200mm

314.060<sup>1</sup>  
Holding Sleeve for no. 314.030  
single, as spare

313.980  
Holding Sleeve for Mini Screws  
single

# INSTRUMENTS FOR TRUAMATOLOGY



**312.300<sup>1</sup>**  
Insert Drill Sleeve 3.5/2.5  
length 42mm, drill bit 2.5mm dia.



**312.480<sup>1</sup>**  
Insert Drill Sleeve 4.5/3.2  
length 80mm  
for long lag screws



**319.310<sup>1</sup>**  
Trocar 2.0mm dia.  
Length 118mm, for percutaneous insertion of 7.0mm cannulated screws



**319.320<sup>1</sup>**  
Drill Sleeve 4.5/2.0  
length 109mm, for percutaneous insertion of 7.0mm cannulated screws



**319.330<sup>1</sup>**  
Drill Sleeve 8.0/4.5  
length 100mm, for percutaneous insertion of 7.0mm cannulated screws



**322.260<sup>1</sup>**  
Handle for Drill Guides  
single



**397.300<sup>1</sup>**  
Drill Sleeve 3.0 with point  
length 55mm



**322.260**  
Handle for Drill Guides  
for nos. 397.150 to 170. single

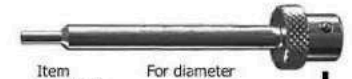

Item	For diameter
<b>397.150</b>	1.5mm
<b>397.160</b>	2.0/2.7mm



**397.170**  
Drill Sleeve 2.7



**312.140<sup>1</sup>**  
Double Drill Sleeve 1.5/1.01  
for 1.5mm cortex screws  
drill bits, 1.5 and 1.1mm dia



**312.220<sup>1</sup>**  
Double Drill Sleeve 2.0/1.5  
for 2.0mm cortex screws



**312.240<sup>1</sup>**  
Double Drill Sleeve 2.7/2.0  
for 2.7mm cortex screws



**312.280<sup>1</sup>**  
Double Drill Sleeve 3.5/2.5  
for 3.5mm cortex screws and 4.0mm cancellous bone screws  
drill bits 3.5 and 2.5 dia.,



**312.460<sup>1</sup>**  
Double Drill Sleeve 4.5/3.2  
for 4.5mm cortex screws  
drill bits: 4.5 and 3.2mm dia



**312.670<sup>1</sup>**  
Double Drill Sleeve 6.5/3.2  
for 6.5mm cancellous bone screws  
drill bit: 3.2mm dia.



**323.260**  
Universal Drill Sleeve 2.7  
Drill bits 2.0 and 2.7mm dia.,  
Suitable for LC-DCP and round hole plates.



**323.360**  
Universal Drill Guide 3.5  
Drill bit 2.5 and 3.5mm dia., And tissue protection for taps nos.  
311.310/320/340, Suitable for LC-DCP and round hole plates.



**323.460<sup>1</sup>**  
Universal Drill Guide 4.5/3.2  
Drill bits 3.2 and 4.5mm dia.



**322.150**  
DCP Drill Guide 2.0  
for neutral and load position  
drill bit 1.5mm dia.



**322.210**  
DCP Drill Guide 2.7  
for neutral and load position  
drill bit 2.0mm dia.



**322.320<sup>1</sup>**  
DCP Drill Guide 3.5  
for neutral and load position, drill bit 2.5mm dia.



**322.440<sup>1</sup>**  
DCP Drill Guide 4.5  
for neutral and load position, drill bit: 3.2mm dia.



**323.350<sup>1</sup>**  
LC-DCP Drill Guide 3.5  
for neutral and load position, drill bit 2.5mm dia.



**323.450<sup>1</sup>**  
LC-DCP Drill Guide 4.5  
for neutral and load position, drill bit 3.2mm dia.



**322.430<sup>1</sup>**  
DCP Hip Drill Guide 4.5  
for neutral and load position, for 4.5mm screws with DHS and angled blade plates, sleeve length 60mm, drill bit 3.2mm dia.



**312.200<sup>1</sup>**  
Triple Drill Sleeve 2.0  
with 3 holes, opposite side 1 hole



**322.240<sup>1</sup>**  
DCP Mandible Drill Guide 2.7 short  
drill bit 2.0mm dia



**322.250<sup>1</sup>**  
DCP Mandible Drill Guide 2.7 long  
drill bit 2.0mm dia



**312.330**  
Insert Drill Sleeve with stop, for 4.5mm screws adjustable length to limit drilling depth, external dia. 4.5mm for drill bits of 3.2mm dia.



**319.300<sup>1</sup>**  
Parallel drill Guide 4.5  
for percutaneous insertion of 7.0mm cannulated screws



**312.710<sup>1</sup>**  
Parallel Wire Guide 2.0mm dia.



**319.010<sup>1</sup>**  
Depth Gauge for 2.7 to 4.0m screws  
measuring range up to 60mm



**319.010<sup>1</sup>**  
Depth Gauge for 2.7 to 4.0m screws  
measuring range up to 60mm



**319.100<sup>1</sup>**  
Depth Gauge for 4.5mm to 6.5mm screws  
measuring range up to 110mm



**332.010<sup>1</sup>**  
Triple Drill Guide  
130° angle, for 130° angled blade plates and for condylar plates,  
drill bit 4.5mm dia.



**312.850**  
Drill Guide with stop 3.5/2.7  
to limit drilling depth



**319.340<sup>1</sup>**  
Protection Sleeve 11.0/8.0  
for percutaneous insertion of 7.0mm cannulated screws



**314.090<sup>1</sup>**  
Holding Sleeve  
length 80mm, for 2.7 to 4.0mm screws



**314.080**  
Holding Sleeve for  
length 80mm for 2.7mm screws and  
3.5mm cannulated screws



**314.280<sup>1</sup>**  
Holding Sleeve, large, length 120mm  
for Nos. 314.190/240/260/270/275



**319.970<sup>1</sup>**  
Screw Forceps, self-holding  
length 85mm, to take screws out of the screw racks



Bending Iron for plates 2.7 and 3.5  
Length 150mm, slid widths 2.5 and 4.5mm, required pairs

Item	Slid placement
<b>329.040<sup>1</sup></b>	4.5/2.5mm
<b>329.050<sup>1</sup></b>	2.5/4.5mm



**312.470**  
Drill Sleeve, pointed



Bending Iron for plates 1.5 and 2.0

Item	Length	Slid width
<b>329.010<sup>1</sup></b>	130mm	2.5mm



**329.020**  
Bending Iron LC-DCP/DCP  
length 250mm, for small and broad LC-DCP, DCP  
slit widths 5 and 7mm, Required in pairs



# INSTRUMENTS FOR TRUAMATOLOGY



**392.000<sup>1</sup>**  
Bending Iron for Kirschner Wires  
length 120mm, for 1.25 to 2.5mm dia.



**392.020**  
Bending Iron for Kirschner Wires  
length 115mm, for 0.8 to 1.25mm dia.



**329.080**  
Bending Iron for Reconstruction Plates 3.5 and 4.5  
length 190mm, required in paris



**397.110**  
Handle with Sleeve  
wit rotating drill guide and anchoring point



**397.120**  
Trocar Point, large, for number 397.110  
for nos. 387.000/397.110



**397.130**  
Cheek Retractor Ring, for number 397.110  
for nos. 387.000/397.110



**321.160<sup>1</sup>**  
Combination Wrench 11mm  
length 140mm



**321.170<sup>1</sup>**  
Pin Wrench  
length 120mm, 4.5mm dia.  
For tension device, distractor and knurled  
nut of insertion handle for intramedullary nail



**321.150<sup>1</sup>**  
Socket Wrench 11mm  
length 200mm



**332.200<sup>1</sup>**  
Slotted Hammer  
length 270mm



**332.160<sup>1</sup>**  
Insertor/Extractor, with Adjustable Clamps  
length 270mm, for the insertion and extraction of angled plates for  
adults and hip plates for adolescents and children as well as tibial  
plateau osteotomy plates.



**332.350**  
Insertor/Extractor  
length 175mm, for infant hip plate and mini hip plate.



**329.290**  
ending Pliers for Reconstruction Plates 2.7 and 3.5  
length 240mm



**329.150<sup>1</sup>**  
Bending Pliers for plate 2.4 to 4.0  
length 230mm



**329.240**  
Bending Pliers for plates



**329.250**  
Anvil, narrow



**329.260**  
Anvil, large



**329.300**  
Bending Press  
length 400mm



**391.950<sup>1</sup>**  
Cutter for thin plates 1.5 to 2.7  
length 256mm



**329.270<sup>1</sup>**  
Bending Pliers  
for reconstruction plates 2.7,  
length 270mm, required in paris



**391.230<sup>1</sup>**  
Cerclage Wire Tightener  
length 260mm  
for twisting, for temporary fixation during reduction



**321.120<sup>1</sup>**  
Tension Device, articulated  
Span 20mm, can also be used as a distractor.  
Colour scale: yellow up to 500N, green up to 1000N,  
red above 1000N.



**332.090<sup>1</sup>**  
Chisel Guide  
with adjustable angle



**399.010**  
Forceps with Sliding Blades  
complete with two interchangeable blades  
length 155mm, weight 42 g, speed lock



**399.020**  
Blade with foot  
single

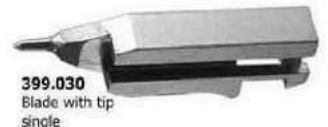

**399.030**  
Blade with tip  
single



**319.020**  
Measuring Device  
fro drill bits, screws, Kirschner wires, and Steilmann pins



**319.440<sup>1</sup>**  
Holding Clip



**391.100<sup>2</sup>**  
Wire Passer  
45mm bending diameter



**391.130<sup>1</sup>**  
Wire Passer  
70mm bending diameter



**391.210<sup>2</sup>**  
Wire Tightener  
length 240mm, with handle and two pegs

# INSTRUMENTS FOR TRUAMATOLOGY



**397.700<sup>1</sup>**  
Handle with quick coupling  
length 150mm

**397.750<sup>1</sup>**  
Cancellous Bone Impactor, rectangular,  
10x20mm Length 140mm

**397.860<sup>1</sup>**  
Gouge, curved, 10mm wide  
length 140mm

**397.830**  
Gouge, straight, 15mm wide  
length 140mm

**397.710<sup>1</sup>**  
Cancellous Bone Impactor, curved, 6mm dia.  
Length 140mm

**397.760<sup>1</sup>**  
Cancellous Bone Impactor,  
rectangular, 10x30mm  
Length 140mm

**397.790**  
Rasp, round  
Length 140mm

**397.870<sup>1</sup>**  
Gouge, curved, 15mm wide  
length 140mm

**397.910<sup>1</sup>**  
Gouge, flat, straight, 16mm wide  
length 140mm

**397.720<sup>1</sup>**  
Cancellous Bone Impactor, curved, 6mm dia, flattened  
Length 140mm

**397.800**  
Rasp, half-round  
length 140mm

**397.810**  
Gouge, straight, 5mm wide  
length 140mm

**397.930**  
Chisel, flat, curved, 16mm wide  
length 140mm

**397.960**  
Chisel, flat, curved, 4mm wide  
length 140mm

**397.730<sup>1</sup>**  
Cancellous Bone Impactor, straight, 8mm dia.  
Length 140mm

**397.850**  
Gouge, curved, 5mm wide  
length 140mm

**397.970**  
Chisel, flat, curved, 8mm wide  
length 140mm

**397.740<sup>1</sup>**  
Cancellous Bone Impactor, rectangular, 6x16mm  
Length 140mm

**397.820**  
Gouge, straight, 10mm wide  
length 140mm

**397.990**  
Chisel, flat, curved, 20mm wide  
length 140mm

Cerclage Wire with eye  
Packs of 10 Wires

Item	Diameter	Length
291.080	0.80mm	280mm
291.010 <sup>1</sup>	1.00mm	280mm
291.020 <sup>1</sup>	1.25mm	280mm
291.030	1.00mm	600mm
291.040	1.25mm	600mm
291.110	1.50mm	280mm
291.120	1.50mm	600mm

Cerclage Wires without eye  
In precut lengths  
packs of 10 wires

Item	Diameter	Length
291.220	0.40mm	150mm
291.240	0.60mm	175mm
291.260	0.80mm	200mm
291.270	1.00mm	250mm
291.280	1.25mm	300mm

- Diameter Ø
- A: 0.2 mm
  - B: 0.3 mm
  - C: 0.4 mm
  - D: 0.5 mm
  - E: 0.6 mm
  - F: 0.7 mm
  - G: 0.8 mm
  - H: 0.9 mm
  - I: 1.0 mm
  - J: 1.2 mm
  - K: 1.5 mm



## Shanz Screws Implantable Material

2 x 60 x 15 mm	5 x 150 x 30 mm
3 x 60 x 15 mm	5 x 160 x 40 mm
3 x 80 x 15 mm	5 x 180 x 40 mm
3 x 80 x 20 mm	5 x 200 x 40 mm
3 x 100 x 15 mm	5 x 220 x 40 mm
3 x 120 x 15 mm	6 x 120 x 40 mm
4 x 80 x 20 mm	6 x 140 x 40 mm
4 x 100 x 20 mm	6 x 150 x 40 mm
4 x 120 x 20 mm	6 x 160 x 40 mm
4 x 140 x 20 mm	6 x 180 x 40 mm
5 x 120 x 30 mm	6 x 200 x 40 mm
5 x 140 x 30 mm	6 x 220 x 40 mm

## Kirschner Wire Implantable Material

Packs of 10 units

St. steel	Diameter	Length	Titanium Alloy
292.060	0.60mm	070mm	492.060
292.080	0.80mm	070mm	492.080
292.090	0.80mm	150mm	492.090
292.100 <sup>1</sup>	1.00mm	150mm	492.100
292.110	1.00mm	280mm	492.110
292.120 <sup>1</sup>	1.25mm	150mm	492.120
292.130	1.25mm	280mm	492.130
292.140	1.40mm	150mm	492.140
292.150	1.40mm	280mm	492.150
292.160 <sup>1</sup>	1.60mm	150mm	492.160
292.170	1.80mm	150mm	492.170
292.180	1.60mm	280mm	492.180

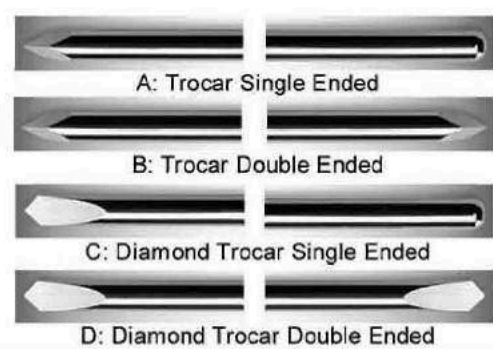
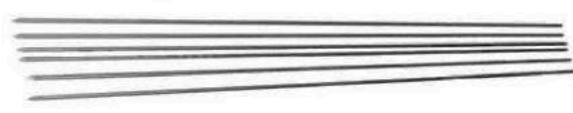

## Kirschner Wire Implantable Material

Packs of 10 units

St. steel	Diameter	Length	Titanium Alloy
292.190	1.80mm	280mm	492.190
292.200 <sup>1</sup>	2.00mm	150mm	492.200
292.210	2.00mm	280mm	492.210
292.230	2.00mm	400mm	492.230
292.250 <sup>1</sup>	2.50mm	150mm	492.250
292.260	2.50mm	280mm	492.260
292.280	2.50mm	400mm	492.280
292.300 <sup>1</sup>	3.00mm	150mm	492.300
292.310	3.00mm	280mm	492.310
292.330	3.00mm	400mm	492.330



International

## **BMA INTERNATIONAL**

Manufacturers & Exporters of Surgical, Orthopedic,  
Micro Instruments and Scissors of all Sorts

---

**Address:** Alama Iqbal Town, Oposite Qadri Masjid,  
Defence Road, Sialkot - Pakistan.

**Tell:** +92-331-6686455

**E-mail:** [info@bmaintl.com](mailto:info@bmaintl.com) ; [bmaintl455@gmail.com](mailto:bmaintl455@gmail.com)

**Web:** [www.bmaintl.com](http://www.bmaintl.com)